



## A Guide to the Rules on Clubs and Balls

The R&A, St Andrews





A GUIDE  
TO THE RULES ON  
CLUBS AND BALLS

by  
R&A Rules Limited

April 2009  
(3rd Edition)

This publication contains guidelines to help manufacturers, Tournament Officials and other interested parties interpret the Rules relating to the design and manufacture of golf clubs and balls, as set out in Appendices II and III of the Rules of Golf.

An interactive version of this guide is accessible from The R&A's website ([www.randa.org](http://www.randa.org)), which includes links to official test protocols and/or video demonstrations relevant to the specific Rule, specification or measurement technique being covered.

As is the case for the Rules themselves, these guidelines will continue to be reviewed and modifications may be required from time to time in the future.

The principles and philosophy expressed within this publication are held by both The R&A and the United States Golf Association.

### **R&A Rules Limited**

With effect from 1st January 2004, the responsibilities and authority of The Royal and Ancient Golf Club of St Andrews in making, interpreting and giving decisions on the Rules of Golf was transferred to R&A Rules Limited. All references to the "R&A" in this guide book mean R&A Rules Limited.



## LIST OF CONTENTS

	Page
<b>INTRODUCTION</b> .....	3
<b>RULE 4 – CLUBS</b>	
Preamble .....	4
Form and Make of Golf Clubs – General (Rule 4-1a).....	4
Wear and Alteration (Rule 4-1b) .....	5
Playing Characteristics Changed (Rule 4-2a).....	6
Foreign Material (Rule 4-2b) .....	6
<b>APPENDIX II – DESIGN OF CLUBS</b>	
Preamble .....	7
1. Clubs	8
a. General .....	8
(i) Traditional and Customary Form and Make .....	9
(ii) Club Composition .....	9
(iii) All Parts must be Fixed .....	9
(iv) There must be No External Attachments .....	10
b. Adjustability.....	11
(i) General .....	11
(ii) Adjustability for Weight.....	12
(iii) Other Kinds of Adjustability .....	13
c. Length.....	14
d. Alignment.....	15
2. Shaft	20
a. Straightness .....	20
b. Bending and Twisting Properties .....	21
c. Attachment to Clubhead .....	22
3. The Grip	24
a. Definition.....	24
b. Cross-section .....	25
(i) Woods and Irons .....	25
(ii) Putters.....	26
(iii) Cross-Sectional Dimension .....	27
(iv) Axis of the Grip .....	27
c. Two Grips .....	27
4. Clubhead	29
a. Plain in Shape.....	29
(i) All Clubs .....	30
(ii) Woods and Irons .....	35
b. Dimensions, Volume and Moment of Inertia .....	37
(i) Woods.....	37
(ii) Irons.....	40
(iii) Putters.....	40
c. Spring Effect and Dynamic Properties .....	41
d. Striking Faces .....	42

## LIST OF CONTENTS

	Page
5. Club Face	
a. General	43
b. Impact Area Roughness and Material	43
(i) Definition of “Impact Area”	44
(ii) Impact Area Roughness	44
(iii) Impact Area Material	45
c. Impact Area Markings	45
(i) Grooves	45
(ii) Punch Marks	46
(iii) Groove/Punch Mark Combinations	46
d. Decorative Markings	48
e. Non-metallic Club Face Markings	49
f. Putter Face	49

### **RULE 5 – THE BALL**

General	50
The List of Conforming Golf Balls	50
Foreign Material (Rule 5-2)	50

### **APPENDIX III – THE BALL**

1. General	51
2. Weight	51
3. Size	51
4. Spherical Symmetry	51
5. Initial Velocity	52
6. Overall Distance Standard	52

### **SUPPLEMENTARY PAPER A**

Advice to Rules Officials Concerning Queries on the Conformity of Clubs at Competitions	53
---	----

### **SUPPLEMENTARY PAPER B**

Guidance on how to Measure Grooves on Club Faces for Conformance to 2008/2009 Rules in the Field	57
--	----

### **SUPPLEMENTARY PAPER C**

New Rules on Club Face Markings (Effective 1 January 2010)	69
--	----

### **SUPPLEMENTARY PAPER D**

Determining the Conformance Status of Grooves in the Impact Area (from 1 January 2010)	73
--	----

## INTRODUCTION

The Rules of Golf (“the Rules”) specify the equipment which may be used to play the game. These specifications can be found in Rule 4 and Appendix II for golf clubs and Rule 5 and Appendix III for golf balls. In general, they are ‘descriptive’ and ‘restrictive’ in nature – defining what golf equipment should look like and limiting how it performs.

The main objective of Rules 4 and 5 and Appendices II and III is to ensure that technological advances in the design and manufacture of golf equipment are in the best interests of the game of golf. Whilst not wishing to stifle innovation, the purpose of the equipment Rules is to protect the traditions of the game, to prevent an over-reliance on technological advances rather than on practice and skill and to preserve skill differentials throughout the game.

It is the role of The R&A’s Equipment Standards Committee to interpret and apply the Rules relevant to clubs and balls, and to determine and advise which conform to the Rules and which do not. The Committee is also responsible for recommending modifications to these Rules, if and when changes are believed to be necessary.

In order to achieve consistency in the decision-making process, a database of all previous decisions is kept and maintained. Also, over time, the Committee has developed a comprehensive set of ‘guidelines’ based on these decisions to help interpret the equipment Rules in a consistent way.

It is the aim of this publication to pass on some of these guidelines to manufacturers, Tournament Officials and other interested parties in an effort to help them interpret and apply the Rules on golf clubs and balls. The purpose of Supplementary Paper A is to offer advice on the procedure an Official should follow when faced with an equipment ruling immediately before or during a competition.

Many of the Rules with regard to clubs and balls can be technical and complex in nature. However, almost without exception, the equipment Rules become understandable after only a brief explanation, or with the aid of a simple diagram. Whenever possible, this guide will attempt to explain both the background to a Rule and its objective. Also, where practical, the guide will offer advice as to how best to carry out any specific measurements.

The guide should be read in conjunction with the 2008 edition of the Rules.

In the event of any doubt over the conformity of a club or ball, the Rules take precedence.

## **RULE 4 – CLUBS**

### **Preamble**

To help try and prevent non-conforming equipment from appearing in the marketplace or from being used, The R&A offers an equipment testing and evaluation service to manufacturers and advice and guidance is available to players. The preamble to both Rule 4 and Appendix II states that:

A player in doubt as to the conformity of a club should consult The R&A.

A manufacturer should submit to The R&A a sample of a club to be manufactured for a ruling as to whether the club conforms with the Rules. The sample becomes the property of The R&A for reference purposes. If a manufacturer fails to submit a sample, or, having submitted a sample, fails to await a ruling before manufacturing and/or marketing the club, the manufacturer assumes the risk of a ruling that the club does not conform to the Rules.

Manufacturers are encouraged to submit drawings, descriptions and/or prototype samples of their new products as early in the development process as possible, and certainly prior to mass production and distribution. This is in order to avoid potentially costly repercussions should they subsequently be ruled not to conform (for example, the existence of large amounts of stock which cannot be sold, or the necessity for product recalls and replacements). When a new design concept is submitted early in the process, production and distribution would not normally have started and golfers should be protected from unwittingly obtaining a non-conforming club to use.

### **Form and Make of Golf Clubs – General (Rule 4-1a)**

Rule 4-1a provides that:

The players' clubs must conform with this Rule and the provisions, specifications and interpretations set forth in Appendix II.

Whilst the submission procedure mentioned above is mostly successful in preventing non-conforming equipment from reaching the market place, not all products are submitted to The R&A for a ruling and sometimes there might be instances when products are submitted after they have been mass produced and distributed for sale. Occasionally, a new or modified Rule can render existing equipment non-conforming. Add to this the fact that many golfers do like to make their own modifications to their clubs, after purchase (see section below on 'Wear and Alteration'),

and it is no longer surprising that non-conforming equipment does sometimes appear in players' bags.

It is the player's own responsibility to ensure that his clubs conform to the Rules but if he is in any doubt as to the conformity of a club, he should consult The R&A. Queries may also be directed to the Committee in charge of a competition and this is where this publication should be a valuable tool.

The penalty for carrying a club which breaches the Rules or which is purposely altered during a round was changed for the 2008 edition of the Rules and no longer results in automatic disqualification. Only if the player were to make a stroke with such a club would the disqualification penalty be applied. The details of this revised penalty situation are clearly laid out at the end of [Rule 4-2](#).

For information relating to the Note to Rule 4-1a, please refer to Section 4c.

### **Wear and Alteration (Rule 4-1b)**

Over time, the face and grip of a club, in particular, will become worn through use. A grip may become so worn that it becomes moulded for the hands, or the grooves on an iron club may become so worn that they no longer conform to the requirements in Appendix II, 5c. Also, as already mentioned above, many golfers like to make post-production modifications to their clubs. Rule 4-1b provides that:

A club that conforms with the Rules when new is deemed to conform after wear through normal use. Any part of a club that has been purposely altered is regarded as new and must, in its altered state, conform with the Rules.

Whilst the clause regarding 'alteration' is self-explanatory, the situation regarding 'wear' benefits from some additional information. In essence, the Rule states that a club which conformed when new cannot be rendered non-conforming due to its wear through normal use. However, a club which did not conform to the Rules when new cannot be worn, through normal use, into a conforming state. Such a club would always be considered non-conforming. In general, 'wear' is defined to be the erosion of material (as opposed to 'damage', which is usually caused by a single occurrence or act). Material decomposition or deterioration is not considered to be wear.

### **Playing Characteristics Changed (Rule 4-2a)**

This Rule states that:

During a stipulated round, the playing characteristics of a club must not be purposely changed by adjustment or by any other means.

The purpose of this Rule is to prevent the player from purposely modifying his club during a round – for example to a flatter lie, a greater loft, an alternative weight distribution or changing the head or shaft. This is regardless of whether the club has been designed to be adjustable.

### **Foreign Material (Rule 4-2b)**

Foreign material must not be applied to the club face for the purpose of influencing the movement of the ball.

The Committee uses this Rule when materials of a temporary nature have been applied to the face – such as saliva, grass juice, chalk, aerosol spray or tape. Permanent attachments or coatings such as plasma spray, ‘balata’-type rubber or paint are dealt with under the club face Rules in Appendix II, 5 (see Section 5 below).

The most important question to ask when ruling on a club which has had something temporarily applied to the face by a player is ‘why has it been put there?’ If a material or substance has been applied to the face in order to protect it or clean it, then it would probably be permitted provided all other Rules are satisfied. However, if the purpose of the application is to influence the movement of the ball, it would be prohibited.

Any type of tape or similar material added to the face is not permitted for any purpose.

## APPENDIX II – DESIGN OF CLUBS

### Preamble

As well as advising manufacturers that they should submit a club to The R&A for a ruling as to its conformity, the preamble to Appendix II also states that:

Where a club, or part of a club, is required to meet a specification within the Rules, it must be designed and manufactured with the intention of meeting that specification

This point can be illustrated using Appendix II, 2a, which states, in part, that “The shaft must be straight”. According to the above clause, this means that manufacturers are expected to design shafts with the *intention* that they will be straight. However, due to the materials commonly used to make shafts and the manufacturing techniques involved, it is not always possible for them to be perfectly straight. As long as it is clear that the shaft is intended to be straight, when evaluating shafts for conformance, a reasonable tolerance is included.

Appendix II divides the club into five separate categories and describes the specifications that must apply to each. The five categories are:

1. Club (General)
2. Shaft
3. Grip
4. Clubhead
5. Club Face

These five categories will now be examined in turn.

## **I. CLUBS**

### **a. General**

Appendix II, 1a states that:

A club is an implement designed to be used for striking the ball and generally comes in three forms: woods, irons and putters distinguished by shape and intended use. A putter is a club with a loft not exceeding ten degrees designed primarily for use on the putting green.

In defining what is meant by the term ‘club’, this Rule makes reference to the three main forms a club traditionally takes, i.e. woods, irons and putters. The words ‘wood’ and ‘iron’ do not necessarily refer to the material the club is made out of, but rather to the general shape of the clubhead. A ‘wood’ club is one where the head is relatively broad from face to back, and it can be made of materials such as titanium, steel or wood. An ‘iron’ club is one where the head is relatively narrow from face to back, and it is usually made of steel. Whilst the distinction between these two club types has been blurred slightly with the emergence of ‘hybrid sets’, rescue and utility clubs, it still remains relevant. The determination of whether a club is a ‘wood’ or an ‘iron’ and, in turn, which Rules apply to it is dealt with based on an overall assessment of the shape and size of the head.

The 2008 Rules make reference to ‘driving clubs’ for the first time (see Sections 5a and 5c) and the basic definition of a driving club is that it is a wood club with a loft of 15 degrees or less. However, a large headed wood club with a loft greater than 15 degrees, which has obviously been designed as a club to be used consistently from the tee, would also be considered a ‘driving club’. Similarly, a 14 degree wood club which is obviously a fairway wood would not be regarded as a driver.

By definition, the loft of a putter must not be greater than 10 degrees. Putters are permitted to have negative loft. However, a negative loft exceeding a magnitude of 15 degrees would not be considered ‘traditional or customary in form and make’ (see Section 1a(i) below).

The Rules and guidelines rarely distinguish between ‘wood’ and ‘iron’ clubs (see Section 5c for the main example of where they do), but there are various instances throughout the Rules where certain specifications do not apply to putters, or at the very least where exceptions may be made for putters. These differences in the Rules will be highlighted at the appropriate places throughout this guide.

Probably as a consequence of these differences, confusion often exists as to which Rules apply to “chippers”, i.e. iron clubs which are specifically designed to be used just off the putting green with a putting stroke. For

clarification on “The Status of a Chipper” see [Decision 4-1/3](#) in *Decisions on the Rules of Golf*.

Appendix II, 1a goes on to state that:

The club must not be substantially different from the traditional and customary form and make. The club must be composed of a shaft and a head and it may also have material added to the shaft to enable the player to obtain a firm hold (see 3 below). All parts of the club must be fixed so that the club is one unit, and it must have no external attachments. Exceptions may be made for attachments that do not affect the performance of the club.

In explaining this Rule, it is easier to break it down into the following four sections:

**(i) Traditional and Customary Form and Make**

The phrase “traditional and customary form and make” does not mean that clubs must look the same as they did 100 years ago. If it did, then steel shafts and metal-headed woods could never have been introduced. This Rule does not even mean that the clubs must look the same as they did 10 years ago – because, as it says in the introduction to this guide, it is not the purpose of the Rules to try and stifle innovation.

In practice, the ‘traditional and customary’ Rule is rarely used – having been largely superseded by the ‘Plain in Shape’ Rule (see Section 4a). However, it is still applied in those cases where the Committee decides that a particular club design deviates from the traditional appearance and/or construction standards, but which may not be covered by a more specific provision within the Rules.

**(ii) Club Composition**

The purpose of this clause is merely to stipulate that multiple shafts and heads are not permitted. It also highlights the fact that it is not essential for a club to have material added to the shaft to form a grip. For further information on a club which has no material added to form a grip, see Section 3.

**(iii) All Parts must be Fixed**

This is interpreted to mean that no part of the golf club should be designed to move, nor should it be promoted as doing so. Therefore, once assembled, all parts of the club must normally be bonded such that they require heat to loosen (see Section 1b below for clubs which are designed to be adjustable). If any part of a club were to incorporate moving powder, pellets, liquid, vibrating wires, rollers, tuning forks, or any number of other features which could be considered a “moving part”, it would be in breach of this Rule.

**(iv) There must be No External Attachments**

The wording of the Rule relating to external attachments was amended in 2008 in order to accommodate a change in interpretation, which previously prohibited any ‘external attachments’ to the club.

Whilst this Rule continues to prohibit the attachment of anything to the club which could potentially have an effect on its performance (e.g. aiming bars or weights), other ‘harmless’ items may now be permitted to be attached to certain parts of the club provided (a) no performance benefit can be derived, and (b) no other Rules are breached, including Rule 14-3 (Artificial Devices, Unusual Equipment and Unusual Use of Equipment).

This change in the wording of the Rule not only helps to legitimise the two existing ‘exceptions’ to the previous interpretation (see below), but it will also allow for the list of acceptable ‘attachments’ to be broadened over time, where appropriate.

Examples of ‘harmless’ attachments that could now be permitted include:

- Temporary, non-permanent attachments to the shaft such as decals for identification or tape to protect the shaft. Such attachments, for identification only, may also be permitted on the clubhead, but these must not be usable for any other purpose (e.g. alignment) or, in the case of driving clubs, must not serve to cause any confusion with the correct identification of a club on the Conforming Driver List. Such attachments should, therefore, be plain in appearance and carefully positioned.
- Temporary, non-permanent attachments to the shaft (e.g. ‘clip-on’ tools), provided such items do not excessively protrude from the shaft, their cross-section conforms to the shape of the shaft and they are sufficiently fixed. Other ‘clip-on’ tools that do not conform to the shape of the shaft (e.g. a club ‘prop’ for use in wet weather) may be attached to the shaft between shots, but must be removed prior to making a stroke.
- Other tape added to the shaft, for example for alignment purposes, provided it is considered semi-permanent, durable, and not easily removable. However, such applications must not be in breach of Rule 14-3.
- Temporary, non-permanent attachments to the butt end of the grip such as tee pegs, ball markers or ball retrieving devices, provided:
  - such items do not cause the grip to be considered moulded for the hands or create a bulge or waist; and/or

- the outer diameter of the item is less than or equal to the outer diameter of the butt end of the grip and the item does not extend beyond the butt end of the grip by more than 2 inches.
- Harmless attachments to the clubhead (other than the face), such as protective coverings or decorative items, provided the item is semi-permanent, durable and not easily removable. However, such items must not excessively protrude from the clubhead and must conform to the shape of the clubhead. Also, for driving clubs, such attachments must not serve to cause any confusion with the correct identification of a club on the Conforming Driver List. Permanent additions to a clubhead would be considered part of the head and, therefore, the head, in its modified state, would have to conform to Appendix II, 4 of the Rules (i.e. for dimensions and ‘plain in shape’).

The two notable exceptions to the pre-2008 ‘external attachments’ Rule were (a) the permission to use lead tape on the shaft or the head, and (b) the use of a suction cup at the end of the grip of a putter to assist with retrieving the ball from the hole. Whilst lead tape can affect the performance of the club and a rubber suction cup would exceed the diameter of the butt end of the grip, the use of both of these items will continue to be permitted on a traditional basis under the new interpretation (see Section 4b(i) below for details on the use of lead tape on driver heads with a high Moment of Inertia).

### **b. Adjustability**

Appendix II, 1b states that:

All clubs may incorporate mechanisms for weight adjustment. Other forms of adjustability may also be permitted upon evaluation by The R&A. The following requirements apply to all permissible methods of adjustment:

- (i) the adjustment cannot be readily made;
- (ii) all adjustable parts are firmly fixed and there is no reasonable likelihood of them working loose during a round; and
- (iii) all configurations of adjustment conform with the Rules.

During a stipulated round, the playing characteristics of a club must not be purposely changed by adjustment or by any other means (see Rule 4-2a).

### **(i) General**

In order to preserve the integrity of Rule 4-2a (Playing Characteristics Changed), this Rule clearly states that it must not be too easy for a player to make adjustments during the course of a stipulated round. This is

interpreted to mean that adjustments must require the use of a special tool, such as an Allen key, a Phillips screwdriver or a custom made device. It must not be possible to make the adjustment just by using the fingers or some other object which would normally be kept in a golfer's pocket, for example a coin or a pitch-mark repair tool.

The above restrictions have been included in the Rules in order to encourage the player to make all of the necessary adjustments to his clubs before starting his round, and to protect him from either unwittingly or purposely making adjustments during a round.

**(ii) Adjustability for Weight**

All clubs may be designed to be adjustable for weight, provided the adjustment mechanism conforms to the conditions described above and in Appendix II, 1b of the Rules. Examples of what would and would not be permitted are illustrated in Figure 1.

Fig. 1 – Adjustability for weight

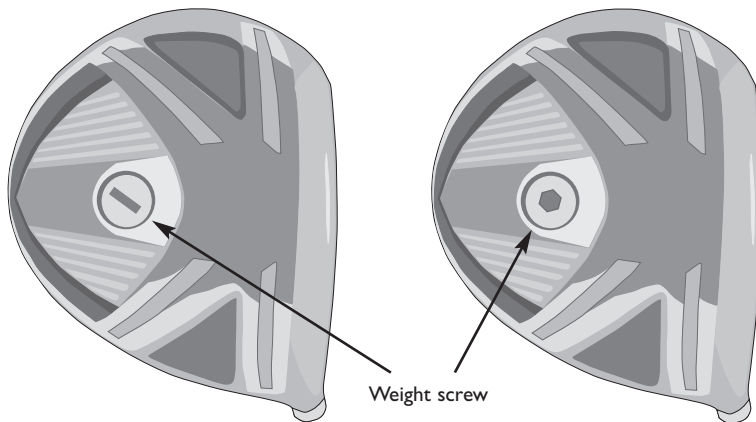

(a) Mechanism can be adjusted by a coin (non-conforming).

(b) Mechanism requires the use of an Allen key (conforming).

As already mentioned in Section 1a, as far as adjustments for weight are concerned, the only exception to the conditions described in (i) above is the addition or removal of lead tape. This is a practice which pre-dates the introduction of the adjustability Rules and is permitted on 'traditional' grounds. Of course, the addition, removal or alteration of lead tape during a round is not permitted (see Rule 4-2a and Decision 4-2/0.5 in *Decisions on the Rules of Golf*).

**(iii) Other Kinds of Adjustability**

The 2008 edition of the Rules on adjustability have been relaxed to allow all clubs to be designed to be adjustable in ways other than weight, not just putters. Given that this could potentially lead to innovations which were never anticipated, manufacturers are encouraged to submit all new ideas and designs in this area for evaluation in the early stages of development.

All permissible methods of adjustment must require the use of a special tool, not just the fingers or a coin, etc. (see above). If, as is often the case, a screw is used to fix the mechanism, the club must, for all practicable purposes, be unusable without the screw being in place and tightly fixed. One exception to this “unusable” requirement is for a long putter with a shaft which dismantles into two shorter lengths for travel purposes. Here, a screw together (“pool cue”) joint is permitted with an Allen key screw, or similar, which penetrates the threaded section of the joint by at least half way. This combination potentially renders the putter usable even when the Allen key is not tightened, or is forgotten.

When assessing the conformity of an adjustable club, it is important to remember the third condition listed in Appendix II, 1b, and to check that it cannot be adjusted into a position which does not conform to the Rules. For example, a putter which is adjustable for lie must not be capable of being adjusted into a position where the shaft diverges from the vertical by less than 10 degrees (see Appendix II, 1d and Section 1d below), or any other position which would render the club non-conforming (see Figure 2).

Fig. 2

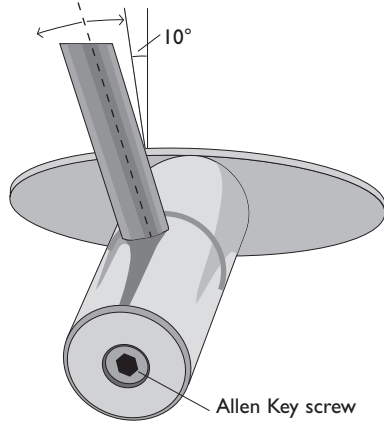

This putter is adjustable for lie – but must not be adjustable into a position where the shaft measures less than 10 degrees from the vertical.

### c. Length

Appendix II, 1c states that:

The overall length of the club must be at least 18 inches (0.457m) and, except for putters, must not exceed 48 inches (1.219m).

This Rule is straightforward and the measurement of woods and irons is well described and illustrated in the Rule Book and the [official test protocol](#). The measurement of length for putters can be illustrated as follows:

Fig. 3

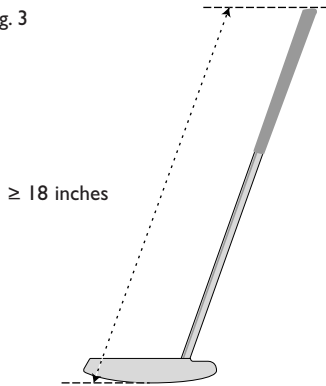

(a) This putter has a straight shaft attached to the clubhead. The measurement for club length follows the axis of the shaft and extends all the way down to the sole.

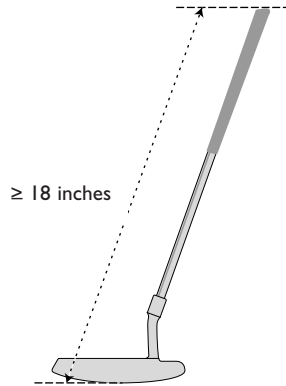

(b) The shaft of this putter is attached to the head via a neck. The measurement for club length does not follow the axis of the bend in the neck, but follows a straight line extension of the straight part of the shaft all the way to the sole.

The above Rules on club length mean that long ‘broomhandled’ putters are still conforming. However, The R&A has adopted a position that clubs designed for chipping, including modified wedges, must be no longer than standard length clubs of similar loft.

### d. Alignment

Appendix II, I d states that:

When the club is in its normal address position the shaft must be so aligned that:

- (i) the projection of the straight part of the shaft on to the vertical plane through the toe and heel must diverge from the vertical by at least ten degrees. If the overall design of the club is such that the player can effectively use the club in a vertical or close-to-vertical position, the shaft may be required to diverge from the vertical in this plane by as much as 25 degrees;
- (ii) the projection of the straight part of the shaft on to the vertical plane along the intended line of play must not diverge from the vertical by more than 20 degrees forwards or 10 degrees backwards.

This Rule is particularly relevant to putters and it exists mainly as a means for disallowing croquet style putters (with vertical shafts) and shuffle-board style strokes (see Figure 4). It also seeks to limit the potential for more standard putters from being used effectively in a vertical or near-vertical position using a pendulum-style motion.

Fig. 4

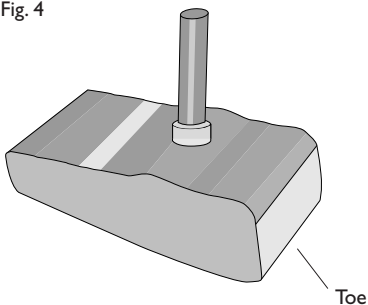

(a) This putter has a vertical shaft and a flat toe - ideal for croquet-style strokes (non-conforming).

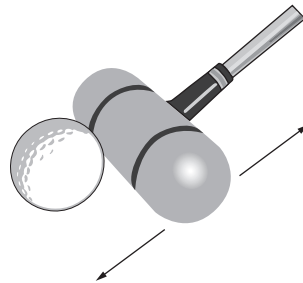

(b) This 'shuffle-board' type putter has a cylindrical shaped head that can slide easily across the ground. The player stands behind the ball, facing the hole and "pushes". The shaft diverges from the vertical by more than 10° in the backwards plane (non-conforming).

For most putters, the “normal address position” is determined by the geometry of the head. The head would be placed on a horizontal flat surface, with the sole touching that surface at a point directly below the centre of the face. The shaft angle would then be measured with the head in this position (see Figure 5).

Fig. 5 – Measuring the angle of a putter shaft

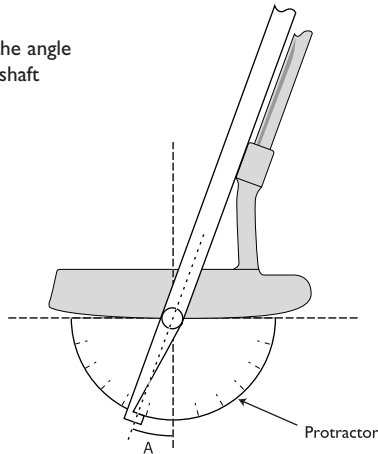

For this putter to conform, angle A must measure at least 10°.

If the putter head shape or weight distribution is very asymmetric, it may be necessary to make a subjective judgement as to where the effective centre of the face is and then to sole the club directly below that point. The position of the head in this instance might not always be the position that was intended when the club was designed, but in some cases a judgement has to be made based on how the club could feasibly and effectively be used (see Figure 6).

Fig. 6 – Club with asymmetric sole

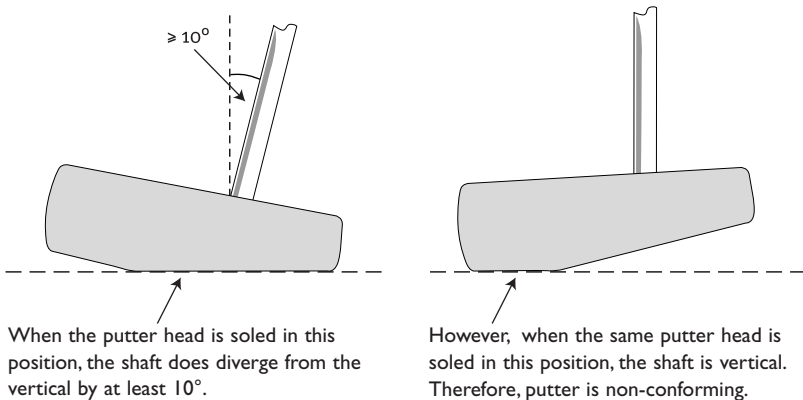

When the putter head is soled in this position, the shaft does diverge from the vertical by at least 10°.

However, when the same putter head is soled in this position, the shaft is vertical. Therefore, putter is non-conforming.

The same subjectivity may also be needed when confronted with a putter which has a very curved sole (see Figure 7). As before, the conformance evaluation would take into account not only the manner in which the putter is designed to be used, but also the way it could feasibly and effectively be used, given the geometry of the head as well as other unique characteristics of the overall design. This interpretation is particularly relevant to long-shafted putters with very curved or multi-planed soles – but standard length putters of 34-38 inches can also be subjected to this assessment.

Fig. 7 – Putter with very curved sole

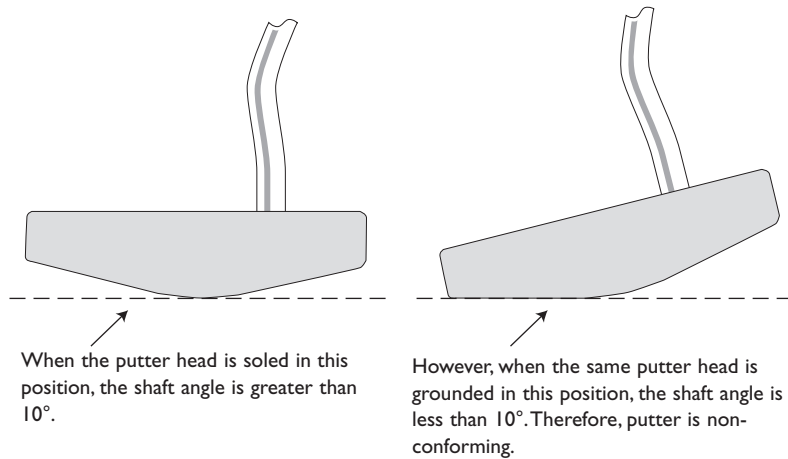

It should be remembered that all putters can usually be positioned in such a way that the shaft diverges from the vertical by less than  $10^\circ$  or even to a position where the shaft itself is vertical. Also, it is unusual for the sole of a putter to be completely flat all the way from heel to toe. When faced with a ruling of this kind, the decision should not be based on whether a player uses the putter with the shaft in a position less than  $10^\circ$  – but whether the putter design facilitates this.

Fig. 8 – Putter with curved sole

(a) The sole of this putter is not considered to be 'very curved'. Therefore, the normal address position is deemed to be in the centre of the face.

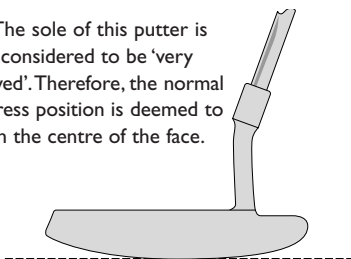

(b) Whilst the angle of the shaft from the vertical is less than  $10^\circ$  in this position, it is not considered to be a feasible address position. Therefore, the putter is conforming and, hence, the player can use it in this position.

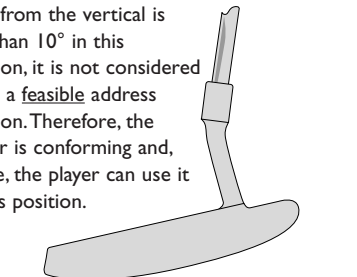

If the overall design of a putter is such that the player can putt effectively with the shaft in a vertical or near-vertical position, it would be ruled contrary to Appendix II, I d, even if the shaft angle does satisfy the 10 degree Rule when the putter is in its “normal address position”. The shaft on such a putter would be required to be increased up to as much as 25 degrees. In assessing whether a putter can be used effectively in such a position and in order to determine what the shaft angle should be increased to, the combination of all of the following features must be considered:

- length of shaft;
- position of shaft attachment to head;
- angle of shaft in toe to heel plane and front to back plane;
- shape and weight distribution of head;
- curvature and shape of sole; and
- intent of the design.

This means that a long putter which has the shaft attached to the toe, a 10 degree lie angle in the toe to heel plane and a curved sole could potentially be ruled non-conforming. Even though each of these features, when taken in isolation, might conform to the Rules, it is the combination of these features which could lead to a non-conforming decision.

This is a good example of an area where Tournament Officials should take care not to make decisions unless they are completely certain that it is correct. If, after examining the club and carrying out all of the appropriate consultations, it is still not possible to give a definitive ruling, a Duration of Competition or Duration of Round Answer should be given (see Supplementary Paper A - Advice to Rules Officials Concerning Queries on the Conformity of Clubs at Competitions).

The determination of a putter’s “normal address position” or whether it can be used in a vertical or close-to-vertical position can be highly subjective and in terms of those putters which are actually submitted to The R&A, the job of making rulings on them is only made easier because it is possible to compare them with previous submissions and rulings.

Appendix II, I d goes on to state that:

Except for putters, all of the heel portion of the club must lie within 0.625 inches (15.88mm) of the plane containing the axis of the straight part of the shaft and the intended (horizontal) line of play.

The intent of the Rule is to prevent centre shafted clubs (see Section 2c below – Attachment to the Clubhead), and the measurement of an iron club is illustrated in Figure 9.

It is worth highlighting that the heel portion of the club extends from the face all the way to the back of the head. Therefore, for unusually shaped heads (e.g. flared or square shaped), where the outermost part of the heel may be further back from the face than for more traditionally shaped heads, the measurement will be completed at that point.

Fig. 9 – Shaft axis/heel measurement

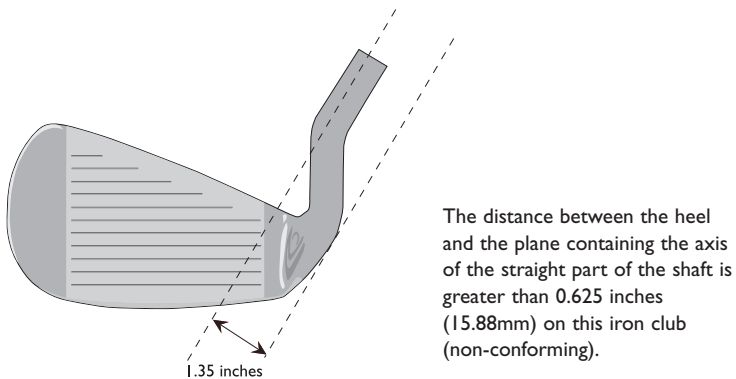

It is also worth stressing that, in most cases, the shaft of a putter may be attached at any point on the clubhead (see Section 2c).

## 2. Shaft

### a. Straightness

Appendix II, 2a states that:

The shaft of the club must be straight from the top of the grip to a point not more than 5 inches (127mm) above the sole, measured from the point where the shaft ceases to be straight along the axis of the bent part of the shaft and the neck and/or socket.

This Rule implies that the shaft must extend to the end of the grip, or at least that the grip should not extend beyond the top end of the shaft more than is necessary to accommodate the butt cap (see Figure 10).

Fig. 10 – Illustrations of “butt caps”

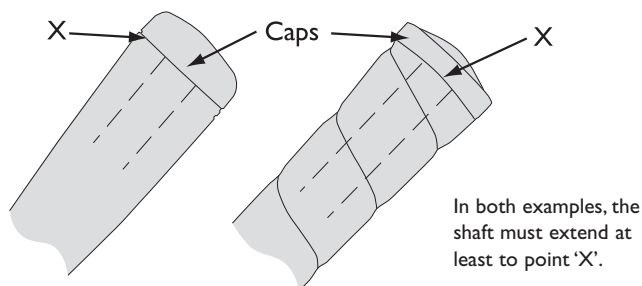

The ‘5-inch’ measurement should be made using a pair of callipers (to measure the depth of the head at the point where the shaft is attached) and a flexible measuring tape, or a piece of string (to measure the length of any bend or bends in the shaft from the point where the shaft ceases to be straight) (see Figure 11). The point where the shaft ceases to be straight can be determined by placing a rigid steel ruler along the straight part of the shaft and marking the point where the shaft and the ruler are no longer in contact.

It would not be possible to measure a bend in a shaft accurately using a normal, stiff ruler. This Rule is particularly relevant to putters where the shaft is inserted directly into the head. (For putter heads that have a ‘neck’ – see Section 2c below).

Fig. 11 – Measuring shaft straightness

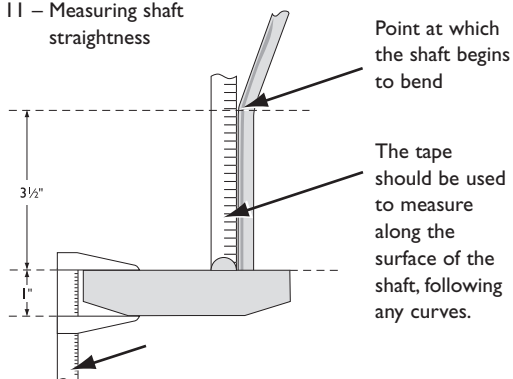

## **b. Bending and Twisting Properties**

Appendix II, 2b requires that:

At any point along its length, the shaft must:

- (i) bend in such a way that the deflection is the same regardless of how the shaft is rotated about its longitudinal axis; and
- (ii) twist the same amount in both directions.

This Rule effectively restricts shafts from being designed to have asymmetric properties, so that irrespective of how the club is assembled, or whichever way the shaft is orientated, it will make no difference to the performance of the club.

There is no easy method of measuring a shaft against this requirement in the field. However, a standard shaft with a circular cross-section would almost certainly conform unless there is specific evidence to the contrary (e.g. advertising claims). A shaft which is not symmetrical in all axes (e.g. a shaft with an oval or rectangular cross-section) could also conform, but due to the unusual nature of such a shaft, it is more likely that it does not. Manufacturers of shafts with unusual cross-sections or other unique features would normally have submitted a sample to The R&A for a ruling prior to marketing and/or manufacturing. Whether such a ruling exists can be confirmed by contacting The R&A.

Most graphite shafts have a small “spine” or “spines” which may make the shaft bend a little differently depending on how it is fitted to the head. The existence of a small spine is generally regarded as being the result of normal manufacturing processes and therefore not a breach of Appendix II, 2b. As previously noted, The R&A recognises that it is difficult to produce a perfectly symmetrical shaft. Therefore, provided that the shaft is manufactured with the intention of meeting the above requirement, The R&A will apply a reasonable tolerance when evaluating shafts for conformance.

Manufacturers of clubs may orientate or align shafts which have spines for uniformity in assembling sets or in an effort to make the shafts perform as if they were perfectly symmetrical. However, a shaft which has been orientated for the purpose of influencing the performance of a club, e.g. to correct wayward shots, would be contrary to the intent of this Rule.

### c. Attachment to Clubhead

Appendix II, 2c requires that:

The shaft must be attached to the clubhead at the heel either directly or through a single plain neck and/or socket. The length from the top of the neck and/or socket to the sole of the club must not exceed 5 inches (127 mm), measured along the axis of, and following any bend in, the neck and/or socket.

**Exception for Putters:** The shaft or neck or socket of a putter may be fixed at any point in the head.

The intent of this Rule is to ensure that the neck is simply a means of connecting the shaft to the clubhead, and that it is not shaped for any other purpose. The most important points to remember are that a club must only have one neck and that it must be “plain”. Also, in order to restrict elaborate shapes and curves, the length of the neck is limited to 5 inches. This measurement should be made in the same way as a bend in the bottom of a shaft (see Section 2a and Figure 11).

The majority of necks are designed to have the shaft inserted into them, and this normally avoids any confusion as to where the neck begins. However, if the neck is inserted into the shaft, the measurement should be taken from the end of the shaft.

Figure 12 contains diagrams of various neck features which would not be permitted.

It should be noted that in most cases, lines which have been painted or lightly engraved onto an otherwise plain neck are permitted. However, a neck designed specifically to accommodate such lines or marks would be considered non-conforming.

Fig. 12

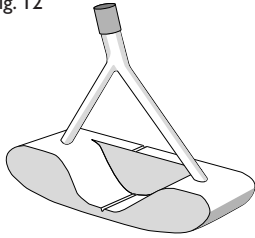

(a) Putter with two necks (non-conforming).

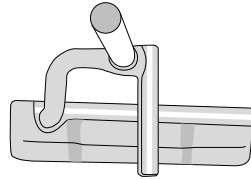

(b) Putter with aiming bar attached to the neck (non-“plain”, non-conforming).



(c) Putter with holes through the neck (non-“plain”, non-conforming).

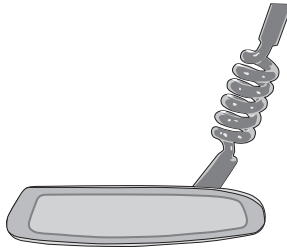

(d) Putter with spiral neck. The length of the neck is measured following the axis of the bends. In this case, the neck is clearly longer than 5 inches (non-conforming).

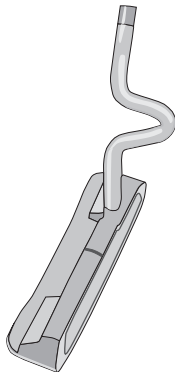

(e) Putter with forward protruding neck. If a neck protrudes forward of the face then the shaft connection must be made at the forward most point. This putter is contrary to that requirement (non-“plain”, non-conforming).

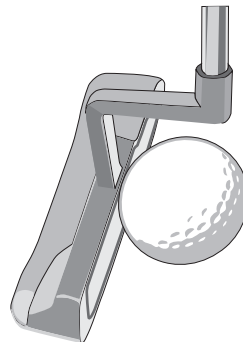

(f) If the shaft or the neck of a putter is attached to the head in the centre of the face, it must protrude forward of the face by no more than 0.84 inches (the radius of a ball). The neck on this putter extends forward by more than half of the ball (non-“plain”, non-conforming).

### **3. The Grip**

#### **a. Definition**

Appendix II, 3 begins by stating that:

The grip consists of material added to the shaft to enable the player to obtain a firm hold. The grip must be fixed to the shaft, must be straight and plain in form, must extend to the end of the shaft and must not be moulded for any part of the hands. If no material is added, that portion of the shaft designed to be held by the player must be considered the grip.

The grip is primarily for the purpose of assisting the player in obtaining a firm hold – so that the club does not slip or twist out of the player's hands. However, the installation of a grip onto the shaft is optional.

When no material is added to the part of the shaft designed to be held by the player, the Rules relating to the grip take precedence over the Rules relating to the shaft. Therefore, the dimensions and cross-section of that area of the shaft could change and equal bending in any direction would not be required (see Section 2b).

In order to accommodate both hands, the grip must be at least 7 inches (177.8 mm) in length. This also applies to clubs which have been designed to be used one-handed. For putters which have two grips, see Section 3c below.

Due to the nature of grips and the grip Rules, it is sometimes very difficult to make a ruling without examining and comparing examples of other grips which are known to either conform or not conform. However, this is not something which would normally be possible in the field. It may help to remember that the overall consideration is that a grip “must not be moulded for any part of the hands”. If a certain feature on the grip enables the player to place his hands in exactly the same position every time, solely by feel, then it must be determined whether that feature renders the grip “moulded for the hands”. An extreme example of a grip which would be ruled “moulded for the hands” is the type of ‘training grip’ often used to help beginners. However, a grip which has subtle changes in surface texture would usually be considered conforming. Likewise, printed markings which assist with the correct placement of the hands visually would not normally be considered non-conforming. Most of the details contained in Sections 3b and 3c below just serve to clarify this and expand on the basic principle.

## b. Cross-section

The next few clauses of Appendix II, 3 state that:

- (i) For clubs other than putters the grip must be circular in cross-section, except that a continuous, straight, slightly raised rib may be incorporated along the full length of the grip, and a slightly indented spiral is permitted on a wrapped grip or a replica of one.
- (ii) A putter grip may have a non-circular cross-section, provided the cross-section has no concavity, is symmetrical and remains generally similar throughout the length of the grip.
- (iii) The grip may be tapered but must not have any bulge or waist. Its cross-sectional dimensions measured in any direction must not exceed 1.75 inches (44.45mm).
- (iv) For clubs other than putters the axis of the grip must coincide with the axis of the shaft.

To take these each in turn:

### (i) Woods and Irons

Grips on woods and iron clubs are allowed to deviate from circular by having a slightly raised rib running along the full length of the grip (often called a “reminder rib”).

“Slightly raised” is interpreted to mean that the maximum and minimum diameters of the cross-section at any point must not differ by more than 0.040 inches (1 mm). Whilst this measurement can be taken using a pair of callipers, due to the nature of gripping materials, the results of these measurements should be interpreted with caution in the field. An additional requirement, mainly for the benefit of manufacturers, is that the dimension of the rib width, from edge to edge, should not exceed 50% of the grip’s internal diameter.

In the case of a standard length grip (approximately 10 inches (254mm) in length), the “full length of the grip” is interpreted to mean that the rib must extend to within 3 inches (76.2mm) of the tip. This should generally be enough to cover the span of the player’s hands on the grip.

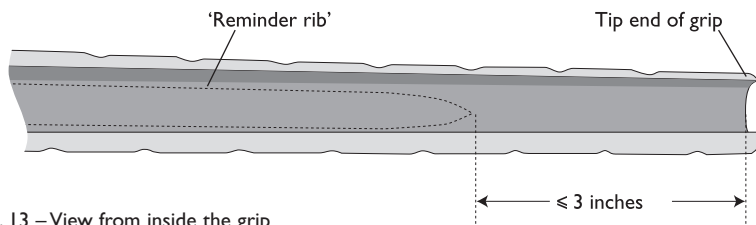

Fig. 13 – View from inside the grip

Simulated leather wrapped grips moulded out of a rubber-like material with an indented spiral or other similar indentations are considered to be circular in cross-section and are permitted, as long as the fingers cannot comfortably fit in between the spirals or indentations. Similarly, features such as lines, dots or other patterned indentations, which are too small to fit even the smallest of fingers, would not of themselves render a grip non-circular in cross-section. However, any feature which is considered wide and deep enough to accommodate a finger or fingers could be ruled “moulded for the hands” and, hence, non-conforming.

**(ii) Putters**

As clearly stated in the Rule, a putter grip may have a non-circular cross-section, provided that, amongst other things, the cross-section remains generally similar throughout the length of the grip.

In order to accommodate the popular (and somewhat traditional) ‘pistol-type’ putter grips and also limit the amount of potential offset, the phrase “generally similar” is interpreted to mean: (i) that the butt (top) end of the grip must not involve a sharp change in slope or dramatic flare on the underside (see Figures 14(a) and (b)); (ii) that the flat front must extend to within an inch (25.4mm) of the top and bottom ends (see Figure 14(c)); and (iii) if the axis of the grip and the shaft do not coincide, the grip must be longer than 10 inches (254mm).

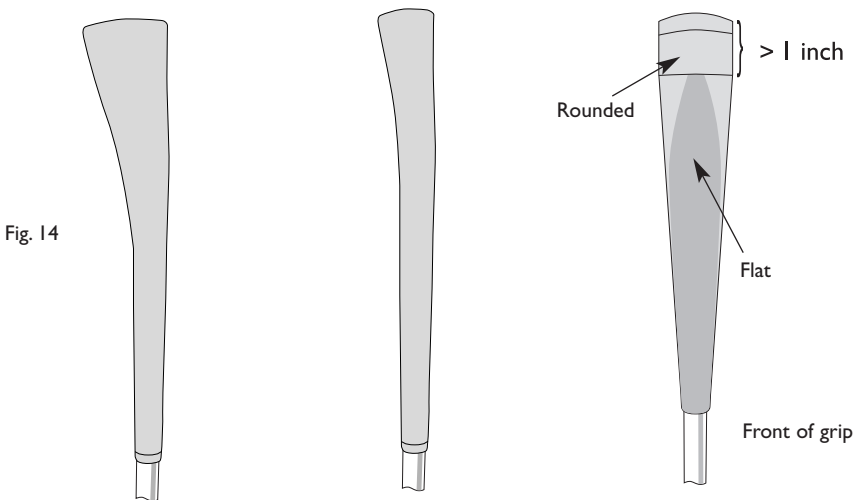

(a) – Non-conforming pistol grip, i.e. the flare is too dramatic.

(b) – Conforming pistol grip. Flat front is continuous throughout the length. The flare is not considered to be too dramatic.

(c) – Non-conforming pistol grip. The flat front does not extend to within an inch of the top.

As with circular grips, features such as lines, dots, or other patterned indentations, which are too small to fit even the smallest of fingers, would not of themselves render a putter grip not “generally similar throughout the length of the grip” or “moulded for the hands”.

**(iii) Cross-sectional Dimension**

This clause is self explanatory and well illustrated in the Rule book.

**(iv) Axis of the Grip**

This clause merely requires that the axis of the circular grip on an iron or wood club coincides with the axis of the shaft. Therefore, you could not have a circular grip with the maximum diameter of 1.75 inches (44.45mm) which has been mounted onto the shaft off-centre or at an angle.

**c. Two Grips**

Appendix II, 3(v) states that:

A putter may have two grips provided that each is circular in cross-section, the axis of each coincides with the axis of the shaft, and they are separated by at least 1.5 inches (38.1 mm).

If a putter were allowed to have two non-circular grips, it would be possible to mount the grips such that their cross-section would not be “generally similar” throughout the entire length (see Section 3b). For this reason, putters which have two grips must have two circular grips.

Where a putter has two grips, these grips will only be considered separate if the gap between them is at least 1.5 inches (38.1 mm) in length. If a smaller gap exists, or if no gap exists, the total length from the bottom of the lower grip to the top of the upper one would be considered ‘one grip’. Therefore, in both of the instances mentioned above, it is unlikely that the grip would conform if two conventional grips were used. Either the exposed piece of shaft between the two grips would constitute a waist, or the fact that two grips met in the middle would cause a bulge. The second example may be overcome if the lower grip is a continuation of the top grip, i.e. a continuation of the same taper and the transition between the two sections is a smooth one.

If a putter does have two grips, the upper grip must be at least 5 inches (127mm) in length. If the grip does not satisfy this requirement, it would be considered to be “moulded for the hands”.

It is worth emphasising that it is not permissible for wood or iron clubs to have more than one grip.

Fig. 15

(a) Two separate grips, both non-circular; lower grip mounted sideways (non-conforming).

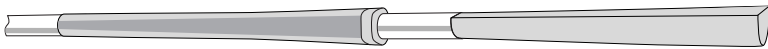

(b) Two circular grips touching (non-conforming).

These grips need to be separated by at least 1.5 inches

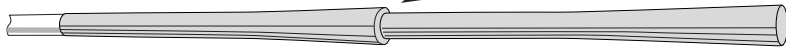

(c) Two circular grips too close (non-conforming).

Gap is less than 1.5 inches.  
Viewed as being one grip with waist

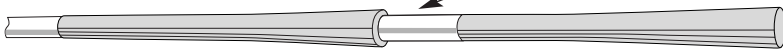

(d) Two circular grips touching (conforming).

Smooth joint – no waist or bulge.  
Continuation of the same taper.



## 4. Clubhead

### a. Plain in Shape

The ‘plain in shape’ requirement in Appendix II, 4a originates from the ‘traditional and customary’ requirement in Appendix II, 1a. It is purely a descriptive rule, although in reality it is very difficult to define exactly what a golf club can or should look like. The following section should go some way towards explaining and illustrating what is and what is not permitted.

The essence of the Rule is encapsulated in the first three sentences:

The clubhead must be generally plain in shape. All parts must be rigid, structural in nature and functional. The clubhead or its parts must not be designed to resemble any other object.

This basically means that the design of the clubhead must have the general appearance of a golf clubhead as opposed to another object and must not incorporate features which are designed to resemble another object (see Figure 16). All parts of the head (including permanent, permissible appendages) must be rigid throughout their length – i.e. it must not be possible to bend or flex them by hand. (see Figure 17).

Fig.16 – Facsimilies of other objects

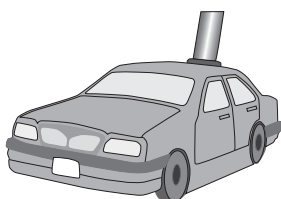

(a) Putter head in the shape of a car (non-conforming).

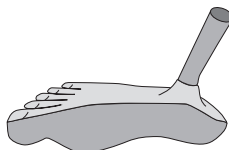

(b) Putter head in the shape of a foot (non-conforming).

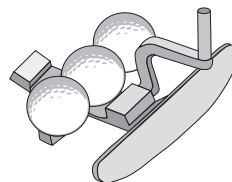

(c) Putter head incorporating three facsimilies of a golf ball (non-conforming).

Fig. 17

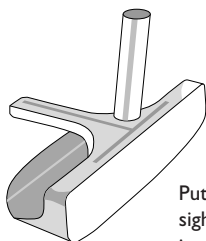

Putter with appendage for aiming/accommodating a sighting line. As long as the appendage is rigid, putter is conforming.

The next section of the Rule freely acknowledges that it is not easy to fully define what is ‘plain in shape’. However, in an attempt to better clarify the Rule and its interpretation, the 2008 edition of the Rule has been split into two categories – one which covers ‘all clubs’ and the other which covers the additional specifications relevant only to ‘irons and woods’. The Rule reflects the more liberalised position for putters which has evolved over the years and it is deliberately more detailed as to what is and what is not permitted for irons and woods. However, it should be remembered that these are not exhaustive or all inclusive lists. Even if a club satisfies all of the points outlined below, there may still be features or characteristics which render it not ‘plain in shape’. An overall assessment of the appearance of the head should always be made.

### (i) All Clubs

The specifications for ‘all clubs’ are as follows:

It is not practicable to define plain in shape precisely and comprehensively. However, features that are deemed to be in breach of this requirement and are therefore not permitted include, but are not limited to:

#### (i) All Clubs

- holes through the face;
- holes through the head (some exceptions may be made for putters and cavity back irons);
- features that are for the purpose of meeting dimensional specifications;
- features that extend into or ahead of the face;
- features that extend significantly above the top line of the head;
- furrows in or runners on the head that extend into the face (some exceptions may be made for putters); and
- optical or electronic devices.

To take each of these clauses in turn:

### Holes through the Face

Holes through the face are not permitted – see Figure 18.

Fig. 18

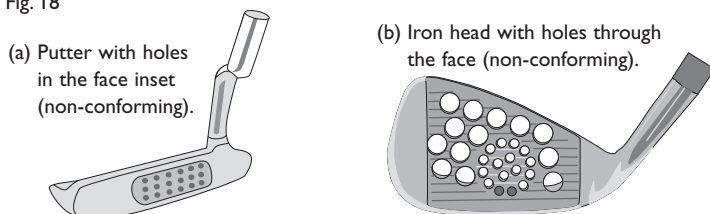

## Holes through the Head

- Holes through the head are not permitted for wood heads – see Figure 19.
- Features within the cavity back of an iron club that form a hole or holes may be permitted, (e.g. support bars), provided that the feature is contained within the outline of the main body of the head and the hole cannot be viewed from above. In addition, the feature must not be designed to affect the performance of the club – see Figure 20.

Fig. 19

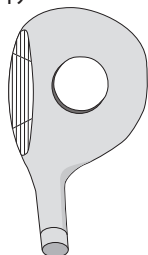

Wood head with hole from crown to sole (non-conforming).

Fig. 20

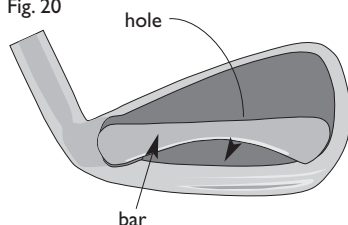

(a) The bar across the cavity back of this iron head creates a hole, but the feature is contained within the outline of the main body of the head (conforming).

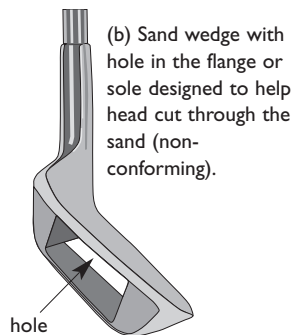

(b) Sand wedge with hole in the flange or sole designed to help head cut through the sand (non-conforming).

- This clause is interpreted very liberally for putters and holes through the head (excluding the face) for any purpose including aiming, sighting or alignment are permitted – see Figure 21 for examples.

Fig. 21

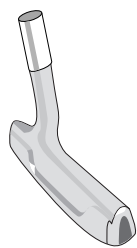

(a) Putter with hole extending from toe to heel (conforming).

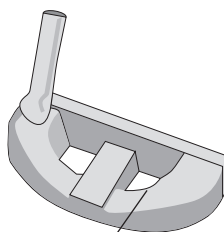

(b) Putter with vertical holes from top to bottom (conforming).

### Features for the purpose of meeting Dimensional Specifications

Appendix II, 4b requires that, for all clubs, the distance from the heel to the toe of the clubhead is greater than the distance from the front to the back (see below). Clubs which incorporate features which are designed to or have the effect of circumventing this requirement are not permitted – see Figure 22.

Fig. 22 – Feature at toe deemed to be for the purpose of meeting dimensional specifications. It would not be considered to be part of the face (non-conforming).

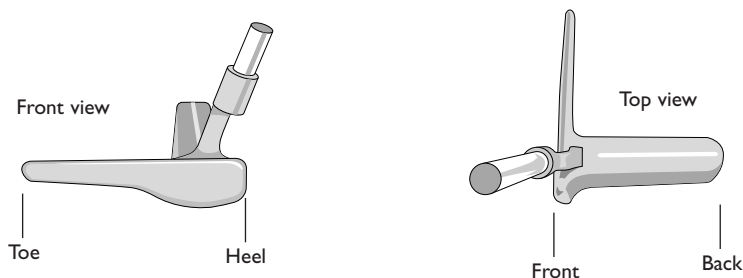

### Features that extend into or ahead of the face

- Permitted features in or on the main body of the head must not extend into the face of an iron or wood club. This would include alignment features on the crown – see Figure 23. Alignment lines which have been engraved or inscribed onto an iron clubhead would generally be permitted.

Fig. 23

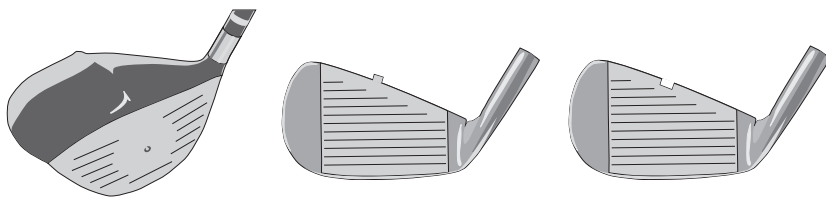

- (a) Raised alignment feature on crown of head, which does not extend into the face (conforming).      (b) Iron head with raised alignment feature on the crown which extends into the face (non-conforming).      (c) Iron head with indented alignment feature on the crown which extends into the face (non-conforming).

- Certain features are permitted to extend into the face of a putter, including alignment features and concavities (or furrows) on the crown (see Section below on Furrows and Runners). However, such features must not have a depth or height greater than 0.25 inches (6.35 mm) when measured against the top line of the face.

- Features of any nature that extend ahead of the face are not permitted on any club – see Figure 24.

Fig. 24

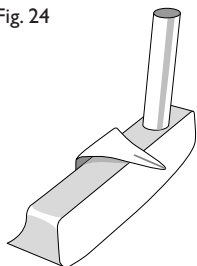

Putter with projection ahead of the face for aiming (non-conforming).

Fig. 25

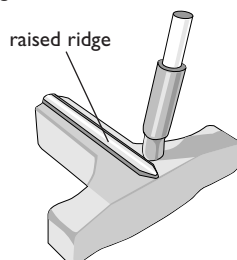

The alignment feature or ridge which extends above the top line of this face of this putter is less than 0.25 inches (6.35mm) in depth. Therefore, putter is conforming.

### Features above the top line of the head

- For putters, alignment or other features must not extend above the top line of the face by more than 0.25 inches (6.35 mm) – see Figure 25.
- For woods and irons, features which otherwise meet the requirements for 'plain in shape' must not extend above the top line of the head by more than 0.1 inch (2.54 mm).
- Permanent or semi-permanent lines or other markings which have been painted, inscribed or otherwise incorporated (see Section 1a(iv)) for alignment purposes are permitted.

### Furrows and Runners

- Furrows or runners which extend into the face of a wood or iron club from any part of the head will not be permitted – see Figure 26.

Fig. 26

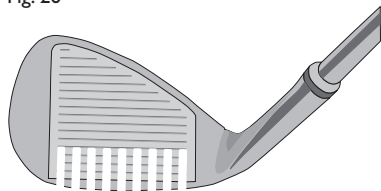

(a) Iron head with rake-like furrows in the sole – which extend into the face (non-conforming).

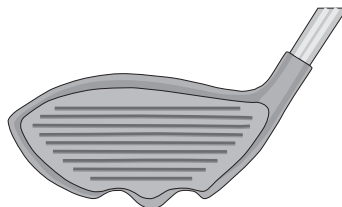

(b) Wood head with runners which extend into the face (non-conforming).

- Whilst this Rule is applied strictly for furrows or runners which may appear on the sole of a putter, exceptions may be made for other parts of the head – see Figure 27.

Fig. 27 Examples of putters with features on the top/crown of the head which extend into the face. These are permitted as long as they do not have a depth greater than 0.25 inches (6.35mm).

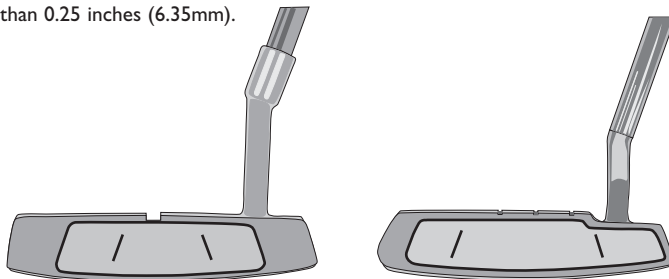

Furrows and/or runners are deemed to extend into the face if the edge of the face has any concavity (point of inflection or turning point). This is determined by placing a straight edge along the edge of the face.

If a runner has been chamfered back away from the face, by at least 45 degrees, then it would not be considered to extend into the face – see Figure 28.

Fig. 28a – Putter with runners at the heel and toe

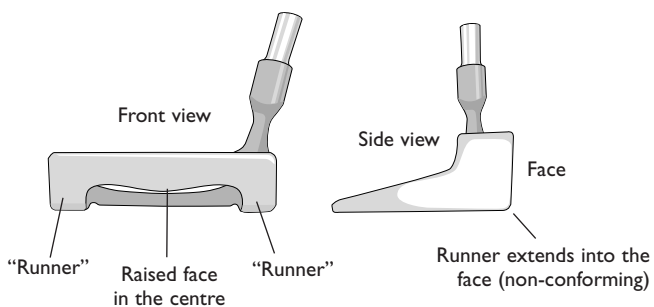
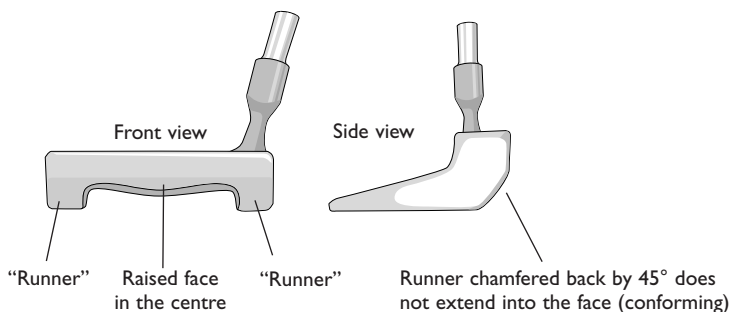

Fig. 28b – Putter with chamfered runners at the heel and toe



## Optical and Electrical Devices

Clubheads which incorporate prisms, mirrors, reflective materials, light beams, metronomes or mechanical devices such as spirit levels are not permitted – see Figures 29 and 30.

Fig. 29 – Optical devices

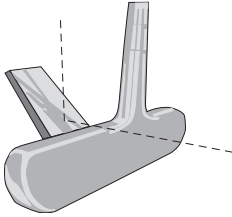

Putter head with sighting mirror attached to the back of the head at 45 degree angle to view target (non-conforming).

Fig.30 – Electrical and mechanical devices

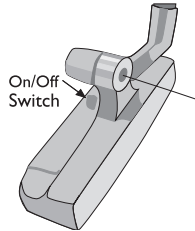

(a) Putter with laser beam sighting mechanism built into the head (non-conforming).

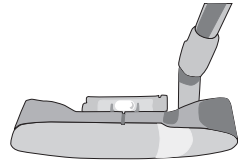

(b) Putter with spirit level at the back of the head (non-conforming).

## (ii) Woods and Irons

The additional specifications for ‘woods and irons are as follows:

- all features listed in (i) above;
- cavities in the outline of the heel and/or the toe of the head that can be viewed from above;
- severe or multiple cavities in the outline of the back of the head that can be viewed from above;
- transparent material added to the head with the intention of rendering conforming a feature that is not otherwise permitted; and
- features that extend beyond the outline of the head when viewed from above.

In essence, the purpose of these requirements is to help preserve the traditional shape of the head when viewed from above. The ‘plain in shape’ Rules for woods and irons are less focused on sole features or other features which cannot be viewed from above. To go through each of these clauses in turn:

### “Viewed from above”

The term “viewed from above” is interpreted to encompass the range from directly above the head to the normal address position.

Fig. 31

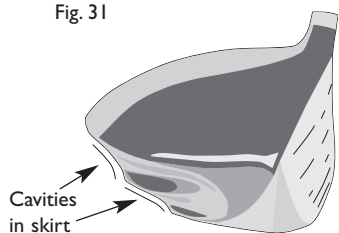

(a) Wood head with cavities in the 'skirt' or sides of the head (conforming).

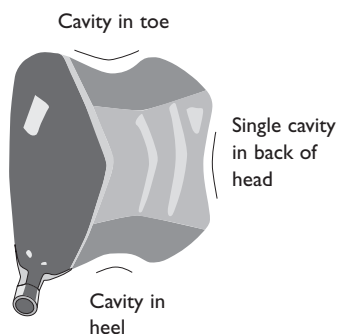

(b) Wood head with cavity in outline of the toe and the heel which can be viewed at address (non-conforming). The single cavity at the back of the head is not 'severe' and, therefore, is permitted.

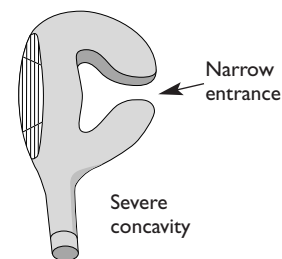

(c) Wood head with 'severe' concavity (non-conforming).

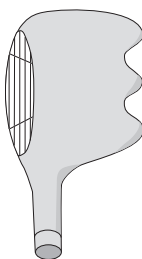

(d) Wood head with multiple cavities in outline of back of head (non-conforming).

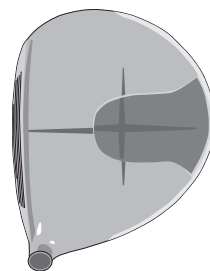

(e) Wood head with cavity in crown of head (conforming – with or without sighting lines).

## Cavities

- The restriction on cavities at the heel and the toe of the head does not prevent cavities around the skirt of the head, which may sometimes be viewed from above.
- Severe cavities (as viewed at address), which go all the way through the head, are not permitted. A "severe" concavity is one where the entrance to the cavity is narrower than its width at any other point (see Figure 31c).
- A single cavity in the back of the head is permitted (see Figure 31b) – but multiple cavities are not (see Figure 31d).
- Cavities in the crown of the head are permitted, even if they are designed primarily as an aid to sighting, aiming or aligning the swing plane or the head position, or to accommodate marking for such aids. However, all cavities on the crown are "filled" for the purpose of measuring the volume of the head (see Section 4b(i) below). See Figure 31 for examples of permitted and prohibited cavities.

### **Transparent Material**

- Clubheads made entirely of transparent material are permitted.
- Transparent material that is added to an otherwise non-plain head does not render the head plain. For example, a wood head which has a vertical hole from the top surface through to the sole would be ruled non-conforming (see Section 4a(i) above and Figure 19). Filling this hole with a transparent material (e.g. perspex or glass), would not alter this ruling.

### **Features extending beyond the outline of the Head**

Any fin, knob, appendage or plate which is protruding from the outline of the head is disallowed, whatever the purpose.

NOTE: Whilst this clause does not apply to putters, The R&A has adopted a position that unusual features which protrude from the outline of the toe or heel of a putter head may be ruled not 'plain in shape' or not 'traditional and customary'.

### **b. Dimensions, Volume and Moment of Inertia**

Appendix II, 4b is divided into three categories – woods, irons and putters.

#### **(i) Woods**

##### **Dimensional specifications:**

When the club is in a 60 degree lie angle, the dimensions of the clubhead must be such that:

- (a) the distance from the heel to the toe of the clubhead is greater than the distance from the face to the back;
- (b) the distance from the heel to the toe of the clubhead is not greater than 5 inches (127mm);
- (c) the distance from the sole to the crown of the clubhead, including any permitted features, is not greater than 2.8 inches (71.12mm)

The Rule goes on to clearly explain and illustrate where these measurements should be made and the [official test protocol](#) has been published. When measuring these dimensions in the field, the best method would be to use a pair of callipers. For the heel to toe measurement, a rigid, straight edge (e.g. a ruler) should be held upright against the extremity of the toe end.

##### **Volume limit:**

The volume of the clubhead must not exceed 460 cubic centimetres (28.06 cubic inches), plus a tolerance of 10 cubic centimetres (0.61 cubic inches).

In practice, many of the larger headed clubheads on the market place have a marking somewhere on the head indicating the approximate volume of the head (this is the ‘cc’ value).

Fortunately, for clubs where there is no indication of volume, there is a fairly simple [method of determining the actual volume of a clubhead in the field](#) and it is broadly based on Archimedes’ Principle and the displacement of water. All that is needed is a large measuring container, half filled with water. The measure of clubhead volume would be the amount by which the water level rises once the clubhead has been submerged into the water. Therefore, if the container is filled with 1 litre of water and the level rises to 1450 millilitres when the head is submerged to the base of the hosel – this would mean that the head has a volume of 450 cubic centimetres.

Fig. 32

The [official test protocol](#) for measuring volume is a more accurate method, but not that much more complicated, and it requires a similar container of water placed on a set of digital weighing scales.

Archimedes’ Principle states that the buoyant force on a submerged object is equal to the weight of the fluid that is displaced by the object – and since water has a specific gravity of 1.0, this means that 1 cubic centimetre of water has a mass of 1 gram. Therefore, the container of water should be placed on the scales and the weight should be set to zero. When the head is submerged in the water, the weight displayed on the scales (in grams) is equivalent to the volume of the head (in cubic centimetres).

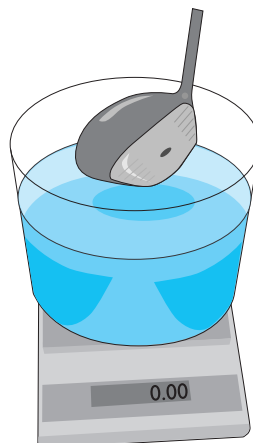

Electronic scales (set to zero) with water-filled container and club head ready for submergence.

In situations where a club is marked with a ‘cc’ value which is in excess of the Rule (i.e. above 460 cubic centimetres), The R&A’s policy is to rule that the club is non-conforming – regardless of the real volume measurement. This is to avoid confusion in the marketplace.

Prior to measuring the volume of a clubhead, the head should be inspected for cavities. All cavities on the crown should be filled with waterproof clay or dough to create a ‘straight line’ which connects the edges of the cavity. The [‘straight line filling technique’](#) does not follow the taper or curvature of the surface of the head, rather the cavity is filled so that it becomes a flat surface which adjoins the outer edges.

Only significant concavities on the sole will be filled, for example any cavity or series of cavities which have a collective volume of greater than 15cc.

**Moment of Inertia (MOI):**

When the club is in a 60 degree lie angle, the moment of inertia component around the vertical axis through the clubhead's centre of gravity must not exceed 5900 g cm<sup>2</sup> (32.359 oz in<sup>2</sup>), plus a test tolerance of 100 g cm<sup>2</sup> (0.547 oz in<sup>2</sup>).

The MOI of a driver head is a measurement of its resistance to twisting and, therefore, it is an indication of the 'forgiveness' of a clubhead.

The [measurement of MOI](#) is one of the few limits within the Rules which cannot easily be tested in the field. This is because the testing equipment is very specialised and it can only be measured by de-shafting the head (the hosel remains on the head for the purpose of the test). However, high MOI is only associated with modern, hollow, high volume driver heads and, due to the publication of the Conforming Driver Head List (see Section 4c below), most of these clubs are now routinely submitted to the Governing Bodies for a ruling – so that they can be included on this List.

As the MOI of a driver head is affected by a change in its weight and the position of the centre of gravity, a driver which is designed to be adjustable for weight must still, of course, conform to the Rules in all configurations (see Section 1b). Moreover, when adding additional weight to a driver (e.g. with lead tape), the player must be sure that the club is still within the limit. To assist golfers with this determination, The R&A has developed a policy whereby if a driver head is submitted for a ruling and it is measured to have an MOI which is close to the limit, the manufacturer will be encouraged to advise its customers that the addition of any other weights to this model (including lead tape), other than the weights which were supplied by the manufacturer, is not permitted as it would likely render the club non-conforming. However, the manufacturer must take care over its claims and must not advertise that the product is over the limit for MOI.

## **(ii) Irons**

When the clubhead is in its normal position the dimensions of the head must be such that the distance from the heel to the toe is greater than the distance from the face to the back.

In practice, due to the shape and size of iron heads, this Rule is never encroached. However, it is retained in the Rules as a safety net. Whilst most irons are still relatively narrow from front to back, the emergence of hybrid irons might mean that this Rule will be needed in the future.

## **(iii) Putters**

Dimensional specifications:

When the clubhead is in its normal address position, the dimensions of the head must be such that:

- the distance from the heel to the toe is greater than the distance from the face to the back;
- the distance from the heel to the toe of the head is less than or equal to 7 inches (177.8 mm);
- the distance from the heel to the toe of the head is greater than or equal to two thirds of the distance from the face to the back of the head;
- the distance from the heel to the toe of the face is greater than or equal to half of the distance from the heel to the toe of the head; and
- the distance from the sole to the top of the head, including any permitted features, is less than or equal to 2.5 inches (63.5 mm).

Note: There is an illustration in the Rule book which tries to put each of these individual limits into context.

The Rule goes on to clearly explain where these measurements should be made and to state that, for unusually shaped putters, the toe to heel dimension may be made at the face. Given all of the dimensional restrictions listed above, which help us define the size and shape of a putter head, this additional clause is rarely, if ever, applied. However, it is retained as a safety net.

It is important to note that appendages are not permitted if their only purpose is to make the clubhead meet the dimensional specifications described in this Rule (see Section 4a(iv) and Figure 22 above).

There are no Rules regulating the volume or MOI of irons and putter heads.

### c. Spring Effect and Dynamic Properties

The design, material and/or construction of, or any treatment to, the clubhead (which includes the club face) must not:

- (i) have the effect of a spring which exceeds the limit set forth in the [Pendulum Test Protocol](#) on file with The R&A; or
- (ii) incorporate features or technology including, but not limited to, separate springs or spring features, that have the intent of, or the effect of, unduly influencing the clubhead's spring effect; or
- (iii) unduly influence the movement of the ball.

Note: (i) above does not apply to putters.

The new Rule limiting 'spring effect' was introduced on 1 January 2008, over 5 years after it was first announced. This Rule now applies to all golfers of all abilities and in all forms of play.

Given that this is purely a performance related limit which cannot be measured easily in the field without specialised equipment and cannot be assessed simply by looking at the club, The R&A has compiled and maintains a [List of Conforming Driver Heads](#). This List can be accessed via The R&A's website ([www.randa.org](http://www.randa.org)) and it is updated weekly.

For competitions restricted to highly skilled players, a [Condition of Competition](#) may be introduced requiring players to use a club which is included on this List. This Condition is an additional requirement for these players, which means that, not only must their clubs conform to the Rules, but the model and loft must also be included on the List of Conforming Driver Heads. This Condition, or additional requirement, is not recommended for use at Club level golf and this is sometimes mistakenly interpreted to mean that the Rule does not apply to Club level golfers. However, for the avoidance of doubt, the position is that the drivers used by Club level golfers must still conform to the Rules, but they do not necessarily have to be on the [Conforming List](#). Most importantly, they must not be included on the Non-Conforming List.

Full details of the Driving Club Condition can be found in [Appendix I](#) of the Rules of Golf.

As well as meeting the requirements of clause (i) in the above Rule, clubs are also tested for compliance to clause (ii) using the Pendulum at points on the face other than at the centre and, depending on the results, other tests may be carried out. Any club which is found to include a feature that is designed to act like a spring, independent of the level of flexibility achieved by the design, could be ruled non-conforming.

If claims of ‘spring like’ qualities are made by the manufacturer which suggest that a club is manufactured to be in excess of the limit, or there is evidence to suggest that the club is indeed over the limit, then the club would be deemed to be non-conforming.

#### d. Striking Faces

Appendix II, 4d states that:

The clubhead must have only one striking face, except that a putter may have two such faces if their characteristics are the same, and they are opposite each other.

The exception for putters was introduced in order to accommodate traditional blade-type putters.

Determining whether a surface constitutes a second (or third) striking face is often a matter of opinion. However, in general, a surface should be considered an additional striking face if:

- the area is flat and it is clearly designed to be used for striking the ball; or
- it is opposite the intended face and consists of a flat surface of a different loft and/or material; or
- it is a flat surface on the toe and/or heel of a cylindrical, rectangular or square head design which could effectively be used to strike the ball; or
- it could otherwise effectively be used to strike the ball.

All three of the putters illustrated in Figure 33 would be ruled non-conforming.

Fig. 33

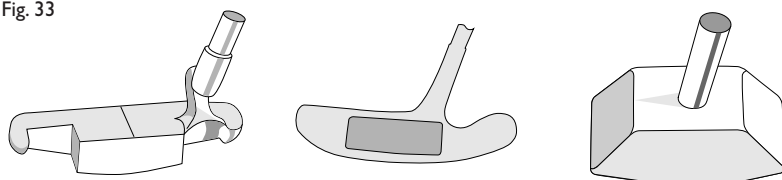

(a) This putter has one small face at the front and a second much longer face at the back.

(b) This putter has a ‘balata’ type inset in the front, but the back of the head is a smooth, flat metal surface.

(c) This putter has two identical surfaces at the front and the back. However, it also has a third striking face at the toe.

The addition of lead tape to the secondary face of a two-faced putter would not be contrary to the Rules.

## **5. Club Face**

### **a. General**

Appendix II, 5a states that:

The face of the club must be hard and rigid and must not impart significantly more or less spin to the ball than a standard steel face (some exceptions may be made for putters). Except for such markings listed below, the club face must be smooth and must not have any degree of concavity.

If claims of excessive spin are made by the manufacturer, or if there is strong supporting evidence of excessive spin, then the club would be deemed to be non-conforming.

The “hardness” Rule is particularly relevant to putters which have a urethane or other “soft” inset in the face.

The measure for hardness is made using a durometer, and The R&A’s interpretation of the Rule is that a putter face must be no less than 85 on a Shore A scale durometer. This number was based on the hardness of a Surlyn ball. A simple measure of hardness in the field would be to use a fingernail. If a fingernail leaves a significant imprint in the face of a club, it is possible that the material does not satisfy the ‘hard and rigid’ requirement. The face of a wood or iron club must be substantially harder than a putter face, i.e. no less than 75 on the Shore D scale.

In the field, ‘rigidity’ is interpreted to mean that the face should not have any visible signs of movement or flex when manual pressure is exerted.

Where there is an inset in the face of the club, it should be flush with the rest of the face so that the face can still be considered smooth with no concavity. As this is sometimes difficult to achieve consistently and there will be manufacturing tolerances, we do allow an inset to be up to 0.006 inches (0.15mm) proud of the rest of the face and 0.004 inches (0.1mm) sunk.

### **b. Impact Area Roughness and Material**

Except for markings specified in the following paragraphs, the surface roughness within the area where impact is intended (the “impact area”) must not exceed that of decorative sandblasting, or of fine milling. The whole of the impact area must be of the same material (exceptions may be made for clubheads made of wood).

**(i) Definition of “Impact Area”**

For iron clubs, the ‘impact area’ is deemed to be that part of the face which lies within 0.8 inches (20mm) either side of the vertical centre line of the face.

For metal wood clubs, the shape of the impact area is generally based on the traditional insets used in persimmon type wood clubs. Figure 34 illustrates the shape and dimensions of this area.

Fig. 34 – Impact Area for Metal Woods

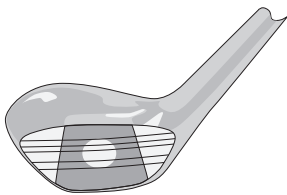

(a) Guideline is based on style of the traditional inset used in persimmon wood clubs

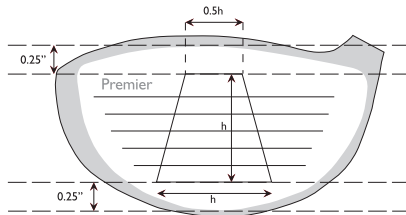

(b) Metal wood head showing size and shape of impact area. The word “Premier” does not encroach the area, therefore the club is conforming.

The height (h) of the trapezium is used to fix the horizontal dimensions – namely “1/2h” at the top and ‘h’ at the base. This ensures that all impact areas are similar.

**IMPORTANT NOTE:**

From 1 January 2010, there will be changes to the definition of the impact area. Full details of these changes can be found in Supplementary Paper C.

**(ii) Impact Area Roughness**

When dealing with the surface roughness of a club face (not including putters, see Section 5f), the claims made by the manufacturer must be taken into account – especially if there is a claim that the roughness of the face influences the movement of the ball. In the absence of such claims, the ruling would be made purely on the amount of roughness there is. Sandblasting or other treatments of roughness greater than 180 micro inches (4.5 µmetre) are not permitted. In addition to this requirement for roughness, milling is not permitted if the crest to trough depth exceeds 0.001 inches (0.025mm). A reasonable tolerance is allowed for both of the above measurements. Non-conforming sandblasting or milling usually feels rough to the touch.

### **(iii) Impact Area Material**

The requirement that the whole of the ‘impact area’ must be of the same material does not apply to clubs made of wood or putters (see Section 5f). The reason why it does not apply to wooden headed clubs is to allow the continued use of wooden clubs which have plastic insets and brass screws in the centre of the face. This design was commonly used in the old persimmon woods, some of which may still be in use. It is worth noting that a club face or inset made of a composite material would be considered to be of a single material and, therefore, would not be contrary to this Rule.

Metal wood club faces which have insets of different material not trapezoidal in shape may be permitted if the height of the inset meets definition of the ‘impact area’ and the width of the inset is the same as the height in at least one point. However, in order to preserve the intent of the ‘same material’ Rule, clubs which have unusually shaped insets of different material (i.e. other than circular, oval, square or rectangular) would not normally be permitted.

If an inset of different material is permitted under the above guideline, the inset would be considered the ‘impact area’ for that club. Therefore, any markings outside that area need not conform to the specifications laid down in Appendix II, 5c. However, such markings must not be designed to unduly influence the movement of the ball.

## **c. Impact Area Markings**

### **(i) Grooves**

- Grooves must not have sharp edges or raised lips (test on file).
- Grooves must be straight and parallel.
- Grooves must have a symmetrical cross-section and have sides which do not converge.
- The width, spacing and cross-section of the grooves must be consistent throughout the impact area.
- Any rounding of groove edges must be in the form of a radius which does not exceed 0.020 inches (0.508 mm).
- The width of each groove must not exceed 0.035 inches (0.9 mm) using the 30 degree method of measurement on file with The R&A.
- The distance between edges of adjacent grooves, and not less than 0.075 inches (1.905 mm).
- The depth of each groove must not exceed 0.020 inches (0.508 mm).

**IMPORTANT NOTE:**

From 1 January 2010, additional specifications will be introduced for grooves and punch marks. Full details of these changes and measurement information can be found in Supplementary Papers C and D.

There are many methods which can be used to measure grooves against the above specifications – most of which require specialist equipment. Supplementary Paper B sets out guidance on how to measure the width, depth and separation of grooves using the less technical ‘ink and scratch’ method and how to determine the conformance status of a club using this method.

**(ii) Punch Marks**

- The area of any punch mark must not exceed 0.0044 square inches (2.84 sq.mm).
- The distance between adjacent punch marks (or between punch marks and grooves) must not be less than 0.168 inches (4.27 mm) measured from centre to centre.
- The depth of any punch mark must not exceed 0.040 inches (1.02 mm).
- Punch marks must not have sharp edges or raised lips (test on file).

Punch marks are almost always circular in shape, and therefore the area of the punch mark can be determined using the calculation  $\pi r^2$  (where  $\pi \approx 3.142$ ). The radius of the punch mark (circle) can be measured using a magnifier (see Supplementary Paper B for details) as can the separation of two punch marks – measured centre to centre. The depth measurement would require the use of a depth probe. Whilst the depth of a punch mark is limited to 0.040 inches (1.02mm) within the Rules, it is highly unlikely that this measurement would ever be queried “in the field”.

**(iii) Groove/Punch Mark Combinations**

If punch marks are used in conjunction with grooves, the following guidelines apply:

**Iron Clubs**

- Small punch marks which are in line with a conforming groove, and which would be totally contained within a continuation of the groove do not have to meet the punch mark to groove specifications (See Figure 35). However, if the diameter of such punch marks exceeds the width of the groove, then they must meet the specifications.

Fig. 35

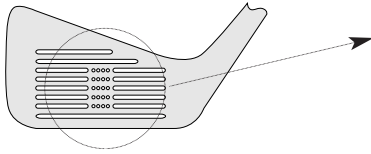

The diameter of these punch marks is smaller than the width of the grooves.



Therefore, if these grooves conform, the 'punch mark to groove separation Rule' does not apply.

- When measuring the centre to centre distance between a punch mark and the end of an in-line groove, the centre of the groove is deemed to be half a groove width from the end edge of the groove (See Figure 37).

Fig. 36

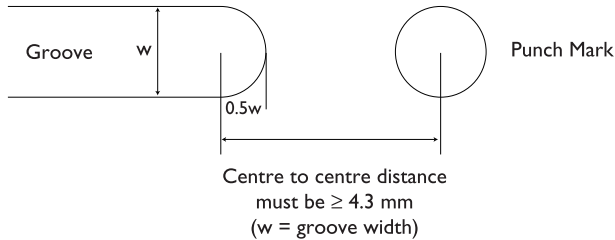

### Metal Wood Clubs

Provided the following three conditions are satisfied, the above interpretation of the specifications for punch marks in line with a groove may also be granted for metal woods, even if the punch marks would not be totally contained by the continuation of the groove:

- there must be no more than three in-line punch marks in the part of the groove that is missing (i.e. in the gap between the ends of the partial grooves);
- the combined area of all of the in-line punch marks in any one such gap must not exceed the area of the missing groove; and
- the separation of the in-line punch marks from adjacent parallel grooves – measured from centre to centre – must be at least four times the width of the groove.

The following diagram attempts to illustrate each of the above conditions:

Fig. 37 – Exceptions for Metal Woods

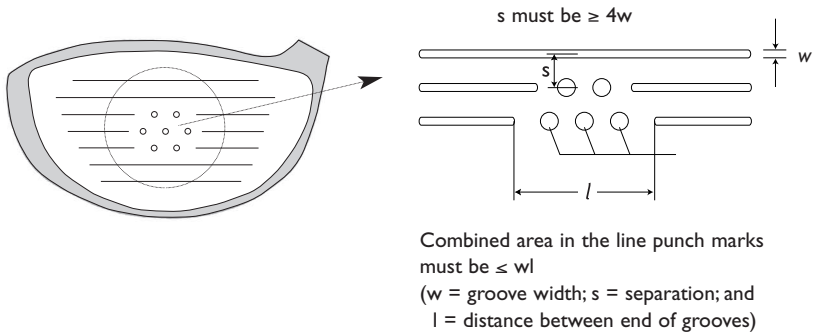

#### d. Decorative Markings

The centre of the impact area may be indicated by a design within the boundary of a square whose sides are 0.375 inches (9.53 mm) in length. Such a design must not unduly influence the movement of the ball. Decorative markings are permitted outside the impact area.

The reason for this Rule is to permit small, decorative logos in the centre of the face or at the side of the ‘impact area’. Non-conforming, decorative markings or logos that marginally encroach on the impact area may be permitted. However, markings outside the ‘impact area’ which are designed to influence the movement of the ball when it has been mis-hit would be contrary to this Rule.

Fig. 38 – Decorative Markings

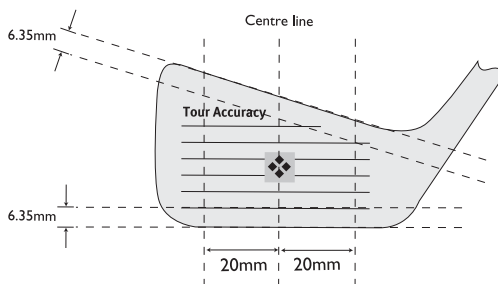

The decorative marking in the centre fits into the boundaries of a square whose sides are 0.375” (9.52mm) in length, and thus conforms with the Rules. However, the word “Accuracy”, which encroaches on the Impact Area, is not deemed to be ‘harmless’ and therefore the club is non-conforming.

**e. Non-metallic Club Face Markings**

The specifications regarding grooves, punch marks and decorative markings that are applicable to metal faces, or faces made from similarly hard materials, do not apply to faces made from other materials and whose loft angle is 24 degrees or less. However, any markings which could influence the movement of the ball are not permitted on such clubs.

**f. Putter Face**

The specifications in Appendix II, 5, with regard to roughness, material and markings in the impact area, do not apply to putters. However, any grooves or other permissible markings on a putter face must not have sharp edges or raised lips.

In addition, if a groove or the grooves on the face of a putter exceed 0.035 inches in width and 0.020 inches in depth, the following guidelines apply:

- The width may not exceed 0.060 inches (1.524mm);
- The width to spacing ratio must be no less than 1:1; and
- The depth must be less than the width, and may not exceed 0.040 inches (1.016mm).

## RULE 5 – THE GOLF BALL

### **General (Rule 5-1)**

Rule 5-1 provides that the ball that a player uses must conform to the Rules and that the use of a ball which does not conform to the Rules will result in disqualification. However, the player would have to make a stroke at a non-conforming ball in order for the disqualification penalty to apply (see also Decision 5-1/3 in *Decisions on the Rules of Golf*).

### **The List of Conforming Golf Balls**

Manufacturers may submit balls to The R&A and the United States Golf Association for testing. Twenty-four samples of each ball type or model need to be submitted and they are then subjected to each of the tests described in this Section. If the samples conform to the Rules, the model is then entered onto the List of Conforming Golf Balls which, since March 2001, has been updated on a monthly basis. The current list can be found on The R&A's website at [www.randa.org](http://www.randa.org). Full details of the golf ball submission procedure can be obtained from The R&A.

Balls remain on the List for a year. Random tests are carried out by The R&A and the USGA on selected balls to ensure that the ball characteristics remain the same. If a conformance issue is identified during random testing, the ball may be removed from the list.

Normally, only the Committees in charge of competitions involving expert players (at District and National level for Amateurs, or at Professional events) introduce a Condition of Competition requiring a player to use a ball included in the Conforming Golf Ball List, the penalty for breach of the Condition being disqualification. However, if this Condition is not in place then the assumption is that a ball used by a player conforms unless there is strong evidence to the contrary e.g. a player used a 1.62 inch golf ball (a ball which used to be in circulation and was permitted under the Rules before finally being prohibited in 1990).

### **Foreign Material (Rule 5-2)**

As with the club, the most important question to ask if confronted with a ball which has had something applied to it by the player is 'why has it been put there?' If the purpose of the application is to influence the movement of the ball it would be prohibited.

Markings applied using a felt-tip pen are not contrary to this Rule. Rules 6-5 and 12-2 encourage the player to put an identification mark on his ball to help ensure that he plays his own ball throughout the round. There are no regulations to limit what or how many markings can be applied to the ball by the player, provided its original markings can be discerned.

## APPENDIX III – THE BALL

### General

Appendix III is divided into the following six categories:

1. General
2. Weight
3. Size
4. Spherical Symmetry
5. Initial Velocity
6. Overall Distance Standard

### 1. General

The ball must not be substantially different from the traditional and customary form and make. The material and construction of the ball must not be contrary to the purpose and intent of the Rules.

Prior to 2008, all of the Rules on the golf ball were precise and quantitative in comparison to the generally more descriptive Rules that relate to clubs. However, in 2008, new language was introduced to protect against any new technology which may be developed in the future which circumvents the intent of the existing Rules. Therefore, along with the specifications listed below, The R&A may conduct additional testing and inspections to identify whether golf balls contain unusual material, construction and/or performance characteristics which might be considered substantially different from the traditional and customary form and make and/or contrary to the purpose and intent of the Rules.

### 2. Weight

Appendix III, 2 states that a ball must not weigh more than 1.620 ounces avoirdupois (45.93gm). This is one of the simpler tests, as all that is required is an accurate set of scales. There is no minimum weight thus a ball can be as light as the manufacturer desires.

### 3. Size

The ball must have a diameter of not less than 1.680 inches (42.67mm), and the [official test protocol](#) uses a metal ring gauge suspended in perspex.

It is important to note that there is no maximum size, the ball can be as large as desired provided it conforms to all other standards.

### 4. Spherical Symmetry

The intent of this Rule is simply to ensure that a ball is manufactured and designed to behave symmetrically.

### **5. Initial Velocity**

There is a [formal test procedure](#) carried out using equipment approved by The R&A to check that golf balls meet the Initial Velocity specification. The intent of the Rule is to limit the speed of the ball off the clubface. Full details of the test specification are available on The R&A's website.

### **6. Overall Distance Standard**

This Rule was first introduced in 1976 in order to restrict the overall distance (carry and roll) a ball can travel under certain specific conditions. This [test protocol](#) is continuously reviewed to ensure that it reflects the modern game and modern equipment.

## SUPPLEMENTARY PAPER A

### ADVICE TO RULES OFFICIALS CONCERNING QUERIES ON THE CONFORMITY OF CLUBS AT COMPETITIONS

#### Introduction

It is the player's responsibility to ensure that his clubs conform with the Rules and if in doubt about a particular club, he would be well advised not to carry it. However, such advice is not always appropriate, particularly when a query arises during or after a competition, in which case a decision is required.

#### Notes on Terminology Used

- "R&A Decision" is one which already exists in The R&A Equipment Standards database or Decisions on the *Rules of Golf* at the time the query arises, though maybe unknown to the player or Official concerned.
- "R&A Ruling" is one that The R&A Equipment Standards Committee or its authorised sub-Committee may make on the club which is the subject of the query. It is made after the query has been communicated to the appropriate Equipment Standards representative, whether it be before, during or after the competition.
- "Duration of Competition Answer" is made by an Official involved in running a stroke-play competition and has no standing after the competition has closed. "Duration of Competition Answers" have no standing beyond the end of the competition and, therefore, the player should be advised to submit the club to The R&A for an official conformance determination prior to using the club in subsequent competitions. The player should also be made aware that any subsequent ruling may be different from the Duration of Competition Answer which was given.
- "Duration of Round Answer" is made by an Official involved in running a match play competition and has no standing after the player has completed that round. "Duration of Round Answers" have no standing beyond the end of the round and, therefore, the player should be advised to submit the club to The R&A for an official conformance determination prior to using the club in subsequent rounds. The player should also be made aware that any subsequent ruling may be different from the Duration of Round Answer which was given.

#### A. Queries Arising Before the Competition Begins

1. Officials should always ascertain why the player, fellow-competitor, opponent or third party is querying the club.

2. A positive ruling should only be given at this stage if the Official is absolutely certain he is correct. As a precautionary measure, always refer to the Rules of Golf, *Decisions on the Rules of Golf* and *A Guide to the Rules on Clubs and Balls* before giving the ruling.
3. If the Official is not certain of the ruling, and time permits, advice should be sought from The R&A. Firstly, it should be determined whether the club has ever been formally submitted for a decision.
4. If an R&A decision exists, and the Official is made aware of that decision in time, the player should be informed accordingly.
5. If there is no R&A decision on record, the Official should provide The R&A with a detailed description of the club. If time permits and appropriate facilities exist, an e-mailed image or faxed drawing should be sent. The R&A will then offer as much guidance as possible based on the information given – and in most cases, offer a recommended ruling.
6. The Official should make a ruling on the club based on the advice given by The R&A. If the club is clearly either ‘conforming’ or ‘non-conforming’, the Official should provide a ruling to that effect. However, if there is even a small amount of uncertainty, the Official should only offer a Duration of Competition or Duration of Round Answer.
7. If, due to the close proximity of a player’s starting time, the Official cannot reasonably seek advice, or is unable to contact The R&A, then he should advise the player not to carry the club for that round.
8. If later advice confirms that the club does conform and the player has already started his round without the club, then the player should be given a formal ruling as soon as possible. This would mean that the player could add the club to his bag during the round (provided he had started with less than 14) or he could carry the club in the next round. If later advice confirms that the club probably conforms and the player has already started his round without the club, then the player should be advised as soon as possible that he can use the club for the duration of the competition in stroke play (Duration of Competition Answer) or for the duration of the round in match play (Duration of Round Answer). This would also mean that the player could add the club to his bag during that round (provided he had started with less than 14).

9. Any player who ignores an Official's advice and carries a doubtful club would be subject to penalty under Rule 4-1a in the event of a subsequent non-conforming Duration of Competition or Duration of Round Answer, or formal ruling. This would apply whether the competition was closed or not.

### **B. Queries Arising During Stroke Play Competition**

1. If the club has already been used, Officials should only accept queries between rounds, or at the conclusion of play before the competition is closed.
2. The Official should ascertain why the player, fellow-competitor or third party is querying the club.
3. If the Official is absolutely certain of the correct decision then the player should be informed (see A2 above).
4. If the Official is unsure of the ruling, the player should be advised that he will receive either a formal ruling or a Duration of Competition Answer before the close of the competition. The procedure is the same as for a query arising before the competition began (see A3 – A6 above).
5. If later advice confirms that the club does not conform, then the player should be given a Duration of Competition Answer or formal ruling as soon as possible, and he should be penalised under Rule 4-1a.

### **C. Queries Arising During Match Play Competition**

1. During a match play event the above procedure may need to be modified.
2. If the query arises between rounds, then it would be too late for a defeated opponent of the player with a suspect club to make a claim, but a query from him would be grounds for checking the club before the player starts his next round.
3. The procedure would be to consult with the player, opponent or third party and obtain all available information before making a determination. Whilst the main procedures would be the same as for stroke play competitions (see A3 – A6 above), there may be more urgency in match play as it would be desirable to know whether the club is non-conforming before the player starts his next round, which might be the same day.

4. If a formal ruling is obtained or a Duration of Round Answer reached, the player should be told as soon as possible. If the decision is that the club does not conform, the official would warn the player that if he carries the club in the next round he would be subject to penalty under Rule 4-1a.
5. If a player makes a claim during a match that his opponent is carrying a non-conforming club, the Official will have to make a ruling under even greater time constraints. Ideally, a ruling should be made before the match is finished. In that event, if there is no clear evidence that the club does not conform, the Official should almost always err towards ruling the club to conform. However, such a ruling would be considered to be a Duration of Round Answer and a more formal decision should be made prior to the next round.
6. Thereafter, if the opponent wins, the procedure is the same as for a query arising between rounds (see C3 and C4 above).

#### **D. Queries Arising After Competition Closed**

Once a competition has closed, there is plenty of time to contact The R&A to find out whether the club conforms or not and/or to submit the club. If it turns out that the club is non-conforming, the decision whether to disqualify the player or not depends on whether he knew the club was non-conforming (see Rule 34-1). This is a question of fact, but in determining the facts, the Committee may wish to consider other evidence as well as the player's own statement.

#### **Conclusion**

The vast majority of golf clubs conform to the Rules and, therefore, equipment conformance queries of this kind are rare. However, queries do arise from time to time and Officials need to know how to deal with them. It is important to remember that it is a player's responsibility to play with conforming clubs. He cannot shift this responsibility to the Officials. For their part, Officials should respond to such queries with due consideration to all parties involved. Appropriate consultations should be made (i.e. referencing the *Rules of Golf*, *Decisions on the Rules of Golf* and *A Guide to the Rules on Clubs and Balls*, contacting The R&A, etc.). If it is not possible to give a definitive ruling straight away, a Duration of Competition or Duration of Round Answer should be given.

In giving Duration of Competition or Duration of Round Answers, Officials in doubt should err towards deeming clubs to conform. Penalising a player for carrying or using a club that later turns out to be conforming is a more serious error than allowing use of a club which later turns out to be non-conforming.

## SUPPLEMENTARY PAPER B

### **GUIDANCE ON HOW TO MEASURE GROOVES ON CLUB FACES FOR CONFORMANCE TO 2008/2009 RULES IN THE FIELD**

#### **Introduction**

The following pages give guidance on how to measure grooves on club faces for width and separation, using the “Ink and Scratch” method, and depth. They concentrate solely on the Rules which apply to the grooves on iron and wood clubs, but, if necessary, the same procedures and equipment can be used to measure grooves on a putter face (see Section 5f).

For those Officials who have not carried out these measurements before, we recommend setting aside time, a day or more prior to the tournament, for groove checking if required, rather than doing it on the first day. It only takes a few minutes to measure the grooves on a club, but it is important not to be rushed. We also recommend practice-measuring on at least six club faces – preferably more – before doing it “in the field”.

A one page summary of the procedure for measuring the width and separation of the grooves on iron and wood clubs is attached, which, in conjunction with the specially designed results sheet, may give sufficient instruction, once the user has gained some experience in measuring grooves. An abbreviated form of the test, appropriate for clubs which comfortably meet the groove specifications, is also outlined.

#### **Groove Width and Separation**

In order to carry out the “Ink and Scratch” method of measuring grooves, the following equipment is required:

1. A thick black marker pen
2. A carbide wedge ‘Marking Tool’ with Allen key (see Figure 2 below)
3. A magnifier
4. A steel ruler

This equipment is available from The R&A at a reasonable cost.

#### **How to Ink and Mark the Grooves**

1. Make sure that the club face and grooves are clean. Also check that the tungsten carbide “wedge” in the marking tool is properly square to the axis of the tool and securely fixed. If not, adjust with the Allen key provided.

2. Use the marker pen to coat a 5 to 10mm length of the edges of ten grooves (and the nearby part of the flat area between them), making sure that the ink gets down into the grooves. The inked pattern thus formed should lie in a line running from sole to top edge of the club face. For new clubs do this about 10mm to one side of the centre of the face (See Figure 1 below). For used clubs do it near the toe, but not at the very end of the grooves (but see also Paragraph 13).

Fig. 1

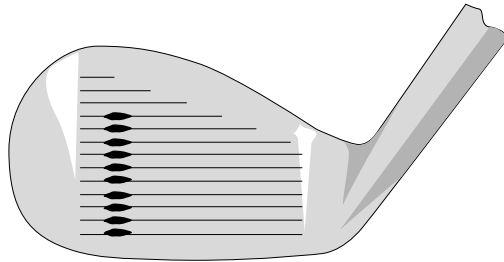

3. When the ink is dry take the marking tool, hold it like a pencil at about 45° to the club face and insert the pointed corner of its tip into one of the blackened grooves. (See Figure 2 below) Using firm but not too heavy pressure, pull the tool along the groove for about 5mm. Two narrow bright lines of exposed metal should now be visible, one on each side of the groove denoting the position of the edges of the grooves. (See Figure 3).
- Do the same for all ten blackened grooves.

Fig. 2

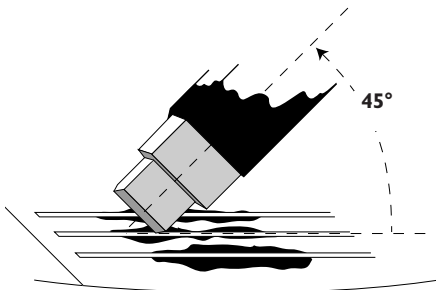
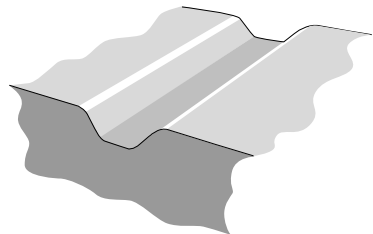

Fig. 3



### How to Use the Magnifier

4. The magnifier comes with two scale glasses, one already fitted and the other in a separate holder. They are identical, except that scale markings are black on one and white on the other. On nearly all club faces the white scale will be easier to read.

5. Rest the clubhead on a table or other surface, so that the club face is horizontal. You may find it helps to rest the club's shaft on your shoulder or on some raised object, in order to leave both hands free to adjust the magnifier.

Since good light is needed it is helpful, indoors, to place a reading lamp close to the clubhead, preferably shining along the direction of the grooves on the club face. Make sure you hold the magnifier in such a way that your fingers do not obscure the light.

6. Place the magnifier on the club face and look through it. By turning the knurled ring on the eyepiece you should be able to bring into sharp focus both the millimetre scale and surface features on the club face. You should also be able to see clearly the bright edges you have scraped on the grooves against the black background.

Notice that the magnifier scale is in millimetres and is marked at intervals of 0.5mm, except immediately to the right of the long vertical zero line, where the intervals are 0.2mm or 0.1mm. You should use this latter part of the scale for the precise measurement of the groove width (See Figure 4).

Fig. 4

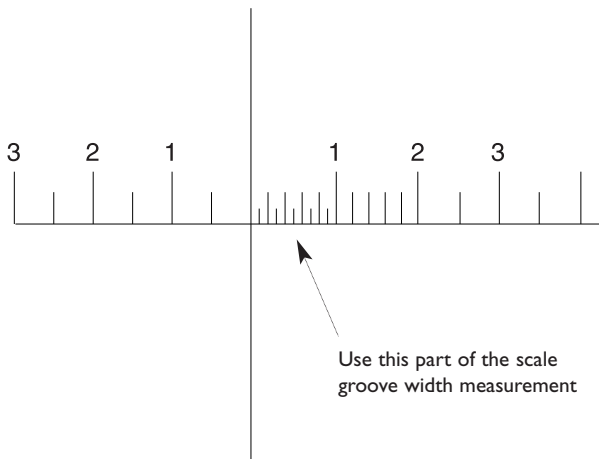

### Measuring the Grooves

7. Use the magnifier to measure the width ( $W$ ) of ten grooves whose edges have been marked by the tool. This may be done by lining up the long vertical zero line on the magnifier scale along the left edge of each groove (ie along the middle of the bright line scratched by the tool) and reading off the position of the other edge on the portion of the magnifier scale which reads to 0.1mm. For best results the scratched line should be about 0.1mm wide, in which case each measurement can be made to the nearest 0.05mm (eg 0.65mm, 0.80mm). If it is appreciably wider than 0.1mm, then too much pressure has been applied in using the marking tool. In that case abandon that particular part of the groove and do a repeat “ink and scratch” a little to one side.

Record all ten groove widths. Often they will be the same, or differ by only 0.05mm.

Calculate and record the average width,  $W_{av}$ ; note the largest measured width,  $W_{max}$ .

Note the second largest width, and the second smallest. Calculate the difference between them, and record it as  $W_{var}$  (“Width variation”).

8. Determine the pitch of the grooves - the distance from a specific point on a groove to the same on the next groove, for example centre to centre, or left edge to left edge (See Figure 5).

Fig. 5

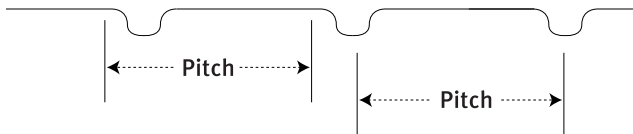

This measurement can be made either with the steel ruler or with the magnifier; but, in most cases, the steel ruler is the more convenient. Measure the left edge to left edge distance from groove 1 to groove 11 (or 2 to 12 etc), and divide this distance by 10 to arrive at the pitch,  $P$ . If a ten groove span is not available, then nine or eight will be satisfactory (but remember to divide by the appropriate number to find  $P$ ).

Alternatively, and this is the only option if a span of fewer than eight grooves is available, you can use the magnifier. Measure the distance from one edge of groove 1 to the corresponding edge of groove 5.

The best way to do this is to position the long zero line of the magnifier scale on the left edge of groove 3 then read off the distances on either side of it to grooves 1 and 5 and add them together. You can, of course, use any two grooves spaced four apart (eg 3 and 7, or 6 and 10); indeed, it may be as well to check your first measurement by repeating the procedure with another such pair of grooves.

It is good enough to make this measurement to the nearest 0.1mm. Then divide the measured span of four grooves by 4 to give the pitch,  $P$ . Whichever method is used, the object is to get the best possible measure of the average groove pitch ( $P$ ).

At this stage it may be worth checking your average by measuring the pitch from one groove to the next one, eg grooves 1 to 2, or 5 to 6. If these measurements differ from the average by more than 0.1mm, then either you calculated the average incorrectly (check it), or the grooves are unevenly spaced. In the latter event you must measure the grooves differently (see Section 14).

### **Errors and Uncertainty in Measuring**

9. With a little practice you can measure the groove width with an uncertainty as little as 0.05mm (ie it could be wrong by at most 0.05mm). In tests for conformity the manufacturer is given the benefit of all of that uncertainty.

This is done by subtracting 0.05mm from all the measurements noted in Section 7, namely  $W_{av}$ ,  $W_{max}$  and  $W_{var}$ , to give “adjusted” values of these quantities. We call them  $AW_{av}$ ,  $AW_{max}$  and  $AW_{var}$ ; it is these which are used in all tests for conformity.

## How to Determine whether Grooves Conform to Pre-2010 Groove Requirements

The specifications set down in Appendix II, 5c (i) are currently interpreted as follows:

- (i) **The width must not exceed 0.9mm (.035”):** We interpret “width” as the average width, and therefore the measured grooves do not conform if  $AW_{av}$  is greater than 0.9mm.  
This interpretation allows individual grooves to exceed 0.9mm, which gives the manufacturer a little more tolerance. However, we put an upper limit to the width of any single groove of 1.0mm. Thus, the grooves do not conform if  $AW_{max}$  is greater than 1.0mm.
- (ii) **The distance between edges of adjacent grooves must be not less than three times the width of a groove.** This means that the pitch of the grooves, as described in Section 8, must not be less than four times the width. Thus, the grooves do not conform if  $P/AW_{av}$  is less than 4.0.
- (iii) **The distance between edges of adjacent grooves must not be less than 1.9mm (.075”):** Here we use the average again, in this case average separation, which is pitch minus average width. Thus, the grooves do not conform if  $P - AW_{av}$  is less than 1.9mm.
- (iv) **Groove widths must be consistent:** We take this to be that the difference in width between the second widest and the second narrowest groove must not exceed 0.1mm. The grooves do not conform if  $AW_{var}$  is greater than 0.1mm.

11. It is recognised that groove measurements made, as these are, at one point along the length of the grooves, are sensitive to small manufacturing errors. Therefore, if a club fails on one of the above criteria, it should not immediately be declared non-conforming; but the whole measuring procedure should be repeated at a slightly different part of the face (say 10mm to the other side of the centre of a club face from the first set). For a club to be declared non-conforming, it must fail to meet the same specification on both sets of measurements. In the case of a single overwidth groove ( $AW_{max}$ ), the same groove must be overwidth on both measurements.

Fig. 6

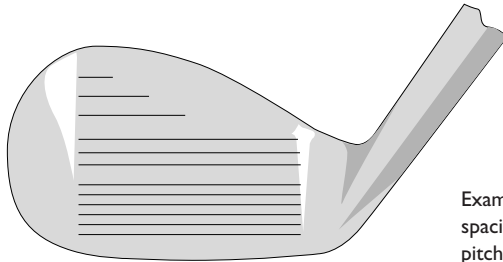

Example of non-uniform spacing where the 'average' pitch is meaningless

### **Irregular or Unusual Grooves**

12. For grooves with markedly varying separation (See Figure 6 above), the above procedures need modification, though the same measuring technique applies. In general, the concept of *average* groove pitch has to be abandoned and groove pitch (or separation) taken for individual pairs of adjacent grooves. In the sample illustrated, the club face would need to be divided into two or even three separation regions.

Difficult cases should be submitted to the The R&A for a ruling.

13. For used clubs with worn grooves the width measurements must be made on grooves which are not worn. These can nearly always be found near the toe of the club, or high on the face. Avoid the extreme end of the grooves since the width sometimes varies there. If it is impossible to find ten unworn grooves, measure as many as possible and make the necessary modifications to the calculation of average width.

If the grooves on a used club have been deliberately altered by filing or the use of a groove scoring tool, then the club should be treated as though it were new and the grooves measured near the centre of the face (see Rule 4-1b).

14. Very occasionally grooves will be found which are either very shallow, or have sides which make an angle of less than 30° to the horizontal. In these circumstances the marking tool will not work properly and the club should be submitted to The R&A for a ruling, although it may be possible to give an "on the spot" conforming ruling if the grooves clearly conform.

## **SUMMARY OF GROOVE MEASURING PROCEDURE**

(The bracketed numbers refer to the corresponding paragraphs in Supplementary Paper B - “Guidance on the Measurement of Grooves on Club Faces”)

1. Clean club face [1]; ink the edges of ten grooves in a 5mm wide band. [2]
2. Check marking tool [1]; use it as described in full instructions [3] to scrape the edges of the inked grooves.
3. Use the magnifier to measure the width of all ten grooves, and record on the results sheet. [4, 5, 6, 7]
4. Calculate and record on the results sheet the average width, the greatest width and the width variation. [7]
5. Calculate and record the adjusted widths which allow for the uncertainties of measurement. [9]
6. Use the ruler to measure a span of ten grooves (eg from groove 1 to groove 11 (not 10), or 2 to 12). [8]  
{OR, if preferred, use the magnifier to measure a four groove span. [8]}
7. Calculate and record the average groove-to-groove pitch. [8]
8. Calculate and record the pitch to width ratio, remembering to use the adjusted width; also calculate the separation (pitch minus adjusted width).
9. Using quantities calculated in 5 and 8 above, answer the questions near the foot of the results sheet to determine whether the grooves conform. [10, 11] Manufacturers are advised to use actual widths in these calculations. [12]
10. Follow the steps on the results sheet to reach a decision on the club, if necessary repeating the measurement. [11]

\* \* \*

NB. Consult the full instructions for grooves with inconsistent spacing, or other unusual features [13, 14, 15].

## **ABBREVIATED PROCEDURE FOR GROOVE MEASUREMENTS**

It may be quite acceptable, for an experienced user of the measuring equipment, to abbreviate the measuring procedure on clubs whose grooves clearly lie well within the specified dimensions.

Firstly inspect the club face by eye, and check whether the grooves are:

- a) unevenly spaced
- b) of unequal width
- c) unusually wide
- d) unusually close together

If any of these conditions apply, then the full measurement must be carried out.

If none of these conditions apply, then the following abbreviated procedure may save some time and effort without affecting the outcome:

Ink and mark three grooves, and measure their width with the magnifier. Take the greatest of the three measured widths and add 0.05mm to it. Call this  $W(+)$ .

*(For example, if the three widths were measured as 0.75mm, 0.80mm and 0.75mm, then  $W(+)$  would be 0.85mm).*

Then measure the pitch,  $P$ , with the steel ruler as described in the full procedure.

Then check:

- Is  $W(+)$  less than 0.9mm?
- Is  $W(+)$  less than  $P/4$ ?
- Is  $W(+)$  greater than 1.9mm?

If all the answers are YES (and you have carried out the initial visual check), the club is certain to meet the requirements of the full tests; and it may be deemed to conform without further testing.

If any of the answers are NO, the full measurement must be carried out.

**IF YOU HAVE ANY DOUBT, CARRY OUT THE FULL MEASUREMENT.**

**GROOVE MEASUREMENT ON \_\_\_\_\_ (club name)**

**Date:** \_\_\_\_\_ **Measured by:** \_\_\_\_\_

**1. Width of Individual Grooves**

Groove 1 =	mm	Groove 6 =	mm
Groove 2 =	mm	Groove 7 =	mm
Groove 3 =	mm	Groove 8 =	mm
Groove 4 =	mm	Groove 9 =	mm
Groove 5 =	mm	Groove 10 =	mm

Average width ( $W_{av}$ ) = \_\_\_\_\_ mm    Greatest width ( $W_{max}$ ) = \_\_\_\_\_ mm

Second greatest minus second smallest width ( $W_{var}$ ) = \_\_\_\_\_ mm

To give benefit of measuring error to the club, subtract 0.05mm (the maximum error) from these widths to give the corresponding “adjusted widths”:

$AW_{av}$ = _____ mm	$AW_{max}$ = _____ mm	$AW_{var}$ = _____ mm
----------------------	-----------------------	-----------------------

**THESE ARE THE WIDTHS USED IN ALL CALCULATIONS HEREAFTER**

**2. Pitch of Grooves**

Span of ten grooves (measured by steel ruler) = \_\_\_\_\_ mm

Therefore pitch,  $P$  = \_\_\_\_\_ / 10 = \_\_\_\_\_ mm

{ALTERNATIVELY: Span of four grooves (measured by magnifier) = \_\_\_\_\_ mm

Therefore pitch,  $P$  = \_\_\_\_\_ / 4 = \_\_\_\_\_ mm

Note pitch measurement in left hand box below. Calculate and enter the other quantities.

$P$ = _____ mm	$P/AW_{av}$ = _____	$P - AW_{av}$ = _____ mm
----------------	---------------------	--------------------------

**3. Test for Conformance**

Is $AW_{av} > 0.9\text{mm}$ ?	YES/NO	Is $P - AW_{av} < 1.9\text{mm}$ ?	YES/NO
Is $AW_{max} > 1.0\text{mm}$ ?	YES/NO	Is $AW_{var} > 0.1\text{mm}$ ?	YES/NO
Is $P/AW_{av} < 4.0$ ?	YES/NO		

IF ALL ANSWERS ARE ‘NO’, GROOVES ON CLUB CONFORM.  
No further measurements are needed.

IF ANY ANSWERS ARE ‘YES’, turn to next sheet and repeat the measurements at a different part of the club face.

Circle the appropriate word: **CONFORMING** **REPEAT**

**REPEAT GROOVE MEASUREMENT ON \_\_\_\_\_ (club name)**

**Date:** \_\_\_\_\_ **Measured by:** \_\_\_\_\_

**1. Width of Individual Grooves**

Groove 1 =	mm	Groove 6 =	mm
Groove 2 =	mm	Groove 7 =	mm
Groove 3 =	mm	Groove 8 =	mm
Groove 4 =	mm	Groove 9 =	mm
Groove 5 =	mm	Groove 10 =	mm

Average width ( $W_{av}$ ) = \_\_\_\_\_ mm    Greatest width ( $W_{max}$ ) = \_\_\_\_\_ mm

Second greatest minus second smallest width ( $W_{var}$ ) = \_\_\_\_\_ mm

To give benefit of measuring error to the club, subtract 0.05mm (the maximum error) from these widths to give the corresponding "adjusted widths":

$AW_{av} =$ _____ mm	$AW_{max} =$ _____ mm	$AW_{var} =$ _____ mm
----------------------	-----------------------	-----------------------

**THESE ARE THE WIDTHS USED IN ALL CALCULATIONS HEREAFTER**

**2. Pitch of Grooves**

Span of ten grooves (measured by steel ruler) = \_\_\_\_\_ mm

Therefore pitch,  $P =$  \_\_\_\_\_ /10 = \_\_\_\_\_ mm

{ALTERNATIVELY: Span of four grooves (measured by magnifier) = \_\_\_\_\_ mm

Therefore pitch,  $P =$  \_\_\_\_\_ /4 = \_\_\_\_\_ mm

Note pitch measurement in left hand box below. Calculate and enter the other quantities.

$P =$ _____ mm	$P/AW_{av} =$ _____	$P - AW_{av} =$ _____ mm
----------------	---------------------	--------------------------

**3. Test for Conformance**

Is $AW_{av} > 0.9\text{mm}$ ?	YES/NO	Is $P - AW_{av} < 1.9\text{mm}$ ?	YES/NO
Is $AW_{max} > 1.0\text{mm}$ ?	YES/NO	Is $AW_{var} > 0.1\text{mm}$ ?	YES/NO
Is $P/AW_{av} < 4.0$ ?	YES/NO		

IF ALL ANSWERS ARE 'NO', OR IF 'YES' ANSWERS ARISE ONLY WHERE THE FIRST MEASUREMENT GAVE 'NO', GROOVES ON CLUB CONFORM. No further measurements are needed.

IF ANY 'YES' ANSWERS ARE REPEATS OF THOSE IN FIRST MEASUREMENT, THE GROOVES DO NOT CONFORM.

Circle the appropriate word: **CONFORMING**    **NON-CONFORMING**

## Groove Depth

Appendix II, 5c(i) goes on to state:

The depth of a groove must not exceed 0.020 inches (0.508mm).

In order to help Officials rule on the groove depth “in the field”, a simple gauge has been developed which is available from The R&A at a reasonable cost.

The gauge consists of a small circular disc which has a raised, thin ridge running across the diameter. This ridge measures exactly 0.022 inches (0.559mm) in depth, which offers a small tolerance suitable for measurements carried out “in the field”.

### Method of Use

In order to judge the depth of a groove on a club, the disc should be placed onto the face with the ridge running along the inside of the groove. The user should then apply pressure to the disc, on both sides of the ridge, to see if the disc will rock from side to side.

If the disc does noticeably rock, then the groove cannot be too deep. It means that the depth of the ridge is greater than the depth of the groove.

If, on the other hand, the disc lies flush with the face and cannot be rocked, it means that the groove is likely to be too deep.

In both instances above, the gauge should be used on at least six grooves within the “impact area” of the face (or near the toe for club faces which are quite worn).

The player should be advised not to use the club in a situation where at least **three** grooves appear to be too deep when using the gauge.

## SUPPLEMENTARY PAPER C

### **NEW RULES ON CLUB FACE MARKINGS – EFFECTIVE FOR CLUBS MANUFACTURED ON OR AFTER 1 JANUARY 2010**

From 1 January 2010, the Rules on club face markings will include the following two additional specifications for clubs other than driving clubs and putters:

The total cross-sectional area of a groove divided by the groove pitch (width plus separation) will be limited to 0.0030 square inches per inch (0.0762 mm<sup>2</sup>/mm);

Groove edge sharpness will be limited to an effective minimum radius of 0.010 inches (0.254 mm). This limit will only apply to clubs with lofts of 25 degrees and above.

In addition, the definition of the ‘impact area’ will be modified as follows:

#### **Irons**

The impact area on irons will be that part of the club where a face treatment has been applied (for instance grooves, sandblasting etc.) or the central strip down the middle of the club face having a width of 1.68 inches (42.67mm), whichever is greater.

#### **Woods**

The impact area on driving clubs and fairway woods will be defined as the central strip down the middle of the clubface having a width of 1.68 inches (42.67mm)

**NOTE:** Grooves and/or punch marks indicating a traditional impact area, or any groove which encroaches into the heel or toe portions of the impact area by less than 0.25 inches (6.35mm), will not be considered to be within the impact area. However, any such markings must not be designed to unduly influence, or have the effect of unduly influencing, the movement of the ball.

For clubs with insets in the face, the boundary of the impact area is defined by the boundary of the inset, as long as any markings outside the boundary do not encroach the impact area by more than 0.25 inches (6.35mm) and/or are not designed to influence the movement of the ball.

Moreover, the inset itself must extend at least 20mm either side of the centre line of the face and to within at least 0.2 inches (5.08mm) of the top line and leading edge of the face.

The new Rules for 2010 in respect of impact area markings are as follows:

c. Impact Area Markings

If a club has grooves and/or punch marks in the impact area they must meet the following specifications:

(i) Grooves

- Grooves must be straight and parallel.
- Grooves must have a symmetrical cross-section and have sides which do not converge (see Figure XI).

Fig. XI

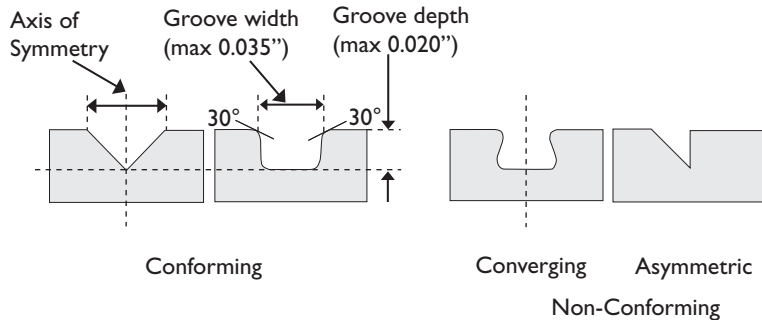

- The width, spacing and cross-section of the grooves must be consistent throughout the impact area.
- The width (W) of each groove must not exceed 0.035 inches (0.9 mm), using the 30 degree method of measurement on file with The R&A.
- The distance between edges of adjacent grooves (S) must not be less than three times the width of the grooves, and not less than 0.075 inches (1.905 mm).
- The depth of each groove must not exceed 0.020 inches (0.508 mm).
- (\*) For clubs other than driving clubs, the cross-sectional area (A) of a groove divided by the groove pitch (W+S) must not exceed 0.0030 square inches per inch (0.0762 mm<sup>2</sup>/mm) (see Figure XII).

Fig. XII

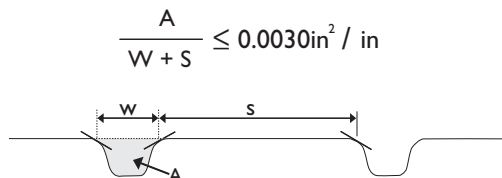

$$\frac{A}{W + S} \leq 0.0030 \text{ in}^2 / \text{in}$$

- Grooves must not have sharp edges or raised lips.
- (\*) For clubs whose loft angle is greater than or equal to 25 degrees, groove edges must have an effective radius which is not less than 0.010 inches (0.254 mm) when measured as shown in Figure XIII, and not greater than 0.020 inches (0.508 mm). Deviations in effective radius within 0.001 inches (0.0254 mm) are permissible.

Fig. XIII

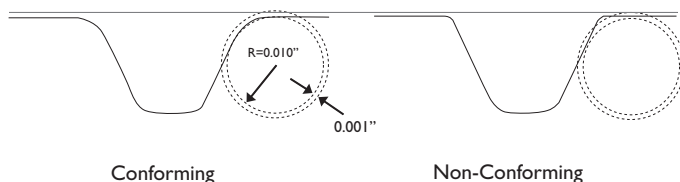

**(ii) Punch Marks.**

- The maximum dimension of any punch mark must not exceed 0.075 inches (1.905 mm).
- The distance between adjacent punch marks (or between punch marks and grooves) must not be less than 0.168 inches (4.27 mm), measured from centre to centre.
- The depth of any punch mark must not exceed 0.040 inches (1.02 mm).
- Punch marks must not have sharp edges or raised lips.
- (\*) For clubs whose loft angle is greater than or equal to 25 degrees, punch mark edges must have an effective radius which is not less than 0.010 inches (0.254 mm) when measured as shown in Figure XIII, and not greater than 0.020 inches (0.508 mm). Deviations in effective radius within 0.001 inches (0.0254 mm) are permissible.

Note 1: The groove and punch mark specifications above marked with an asterisk (\*) apply only to clubs manufactured on or after 1 January 2010.

Note 2: Effective 1 January 2010, the Committee may require, in the Conditions of Competition, that the player's clubs must conform to the groove and punch mark specifications above marked with an asterisk (\*). This condition is recommended only for competitions involving the highest level of expert player.

**d. Decorative Markings**

The centre of the impact area may be indicated by a design within the boundary of a square whose sides are 0.375 inches (9.53 mm) in length. Such a design must not unduly influence the movement of the ball.

Decorative markings are permitted outside the impact area.

**e. Non-metallic Club Face Markings**

The above specifications do not apply to clubheads made of wood on which the impact area of the face is of a material of hardness less than the hardness of metal and whose loft angle is 24 degrees or less, but markings which could unduly influence the movement of the ball are prohibited.

**f. Putter Face Markings**

Any markings on the face of a putter must not have sharp edges or raised lips. The specifications with regard to roughness, material and markings in the impact area do not apply.

## SUPPLEMENTARY PAPER D

### DETERMINING THE CONFORMANCE STATUS OF GROOVES IN THE IMPACT AREA – FROM 1 JANUARY 2010

The following algorithm will be used to determine the conformance status of clubs to the new Rules on impact area markings from 1 January 2010, regardless of what method has been used to obtain the measurements. Within the following procedure, the inherent difficulty of manufacturing grooves has been taken into consideration. However, it should be stressed that clubs must be designed and manufactured with the intent of conforming to the Rules.

**Note that, for all dimensional limitations described below, each measurement will be based on a confidence level of at least 95% confidence as determined by standard Gauge R&R procedures. All measurements will include appropriate outlier controls to ensure that rulings are not based on spurious or anomalous data. Improvements to measurement techniques and consequently the associated measurement tolerances may be introduced at any time.**

#### (i) Groove Width

- If 50% or more of the measured groove widths exceed 0.035" (0.889mm) then the club is non-conforming.
- If any single measured groove width exceeds 0.037" (0.940mm) then the club is non-conforming.

#### (ii) Groove Depth

- If 50% or more of the measured groove depths exceed 0.020" (0.508mm) then the club is non-conforming.
- If any single measured groove depth exceeds 0.022" (0.559mm) then the club is non-conforming.

#### (iii) Groove Separation

- If 50% or more of the measured groove separations are less than three times the maximum adjacent measured groove width then the club is non-conforming.
- If any single measured groove separation is less than three times the maximum adjacent measured groove width minus 0.008" (0.203mm) then the club is non-conforming.
- If 50% or more of the measured groove separations are less than 0.075" (1.905mm) then the club is non-conforming.

- If any single measured groove separation is less than 0.073” (1.854mm) then the club is non-conforming.

#### **(iv) Groove Consistency**

Grooves must be designed and manufactured with the intent of being symmetric, parallel and consistent throughout the impact area.

Consistency is interpreted to be:

- The range of measured groove widths cannot exceed 0.010” (0.254mm).
- The range of measured groove depths cannot exceed 0.010” (0.254mm).

Inconsistencies in the groove width, spacing or cross-section for the purpose of influencing the movement of the ball are not permitted, regardless of whether the above requirements are satisfied.

#### **(v) Area over Width Plus Separation**

- If 50% or more of the measured values of  $A/(W+S)$  are greater than 0.0030 square inches per inch (0.0762mm<sup>2</sup>/mm) then the club is non-conforming.
- If the measured value of  $A/(W+S)$  value for any single groove is greater than 0.0032 square inches per inch (0.0813mm<sup>2</sup>/mm) then the club is non-conforming.

#### **(vi) Groove Edge Radius**

Rounding of groove edges shall be in the form of a radius having an **effective** radius not less than 0.010” (0.254mm) as determined by the [two circles method](#), nor greater than 0.020” (0.508mm). The following two criteria are used for determining conformance:

- If 50% or more of the upper groove edges or 50% or more of the lower groove edges fail the two circles method subject to a 10 degree angular allowance, then the club is non-conforming.
- If any single groove edge protrudes more than 0.0003” (0.0076mm) outside the outer circle, then the club is non-conforming.

#### **(vii) Punch Marks**

- If 50% or more of the punch mark edges fail the two circles method subject to a 10 degree angular allowance, then the club is non-conforming.
- If any single punch mark edge protrudes more than 0.0003” (0.0076mm) outside the outer circle, then the club is non-conforming.

NB: As a result of the new Rule limiting the  $A/(W+S)$  of grooves, from 1 January 2010 the volume of punch marks in the impact area must not exceed the allowable value for an equivalent groove (that is,  $0.0030 \text{ in}^3$  per square inch ( $0.0762 \text{ mm}^3/\text{mm}^2$ ) of impact area covered by punch marks).

The R&A is golf's world rules and development body and organiser of The Open Championship. It operates with the consent of 130 national and international, amateur and professional organisations, from almost 120 countries and on behalf of an estimated 30 million golfers in Europe, Africa, Asia Pacific and The Americas (outside the USA and Mexico). The United States Golf Association (USGA) is the game's governing body in the United States and Mexico.